

aiwa

DVD PLAYER
PLATINA DVD

XD-DV520

OPERATING INSTRUCTIONS MANUAL DE INSTRUCCIONES

Owner's record

For your convenience, record the model number and serial number (you will find them on the rear of your set) in the space provided below. Please refer to them when you contact your Aiwa dealer in case of difficulty.

Model No.	Serial No. (Lot No.)

For assistance and information,
call toll free 1-800-BUY-AIWA.

(United States and Puerto Rico)

En (English)

E (Español)



WARNING

TO REDUCE THE RISK OF FIRE OR ELECTRIC SHOCK, DO NOT EXPOSE THIS APPLIANCE TO RAIN OR MOISTURE.

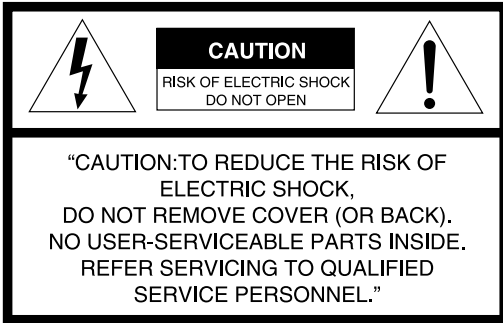

Explanation of Graphical Symbols:



The lightning flash with arrowhead symbol, within an equilateral triangle, is intended to alert the user to the presence of uninsulated "dangerous voltage" within the product's enclosure that may be of sufficient magnitude to constitute a risk of electric shock to persons.



The exclamation point within an equilateral triangle is intended to alert the user to the presence of important operating and maintenance (servicing) instructions in the literature accompanying the appliance.

PRECAUTIONS

Read the Operating Instructions carefully and completely before operating the unit. Be sure to keep the Operating Instructions for future reference. All warnings and cautions in the Operating Instructions and on the unit should be strictly followed, as well as the safety suggestions below

Installation

- 1 **Water and moisture** — Do not use this unit near water, such as near a bathtub, sink, swimming pool, or the like.
- 2 **Heat** — Do not use this unit near sources of heat, including heating vents, stoves, or other appliances that generate heat. This unit should not be placed in temperatures less than 5°C (41°F) or greater than 35°C (95°F).
- 3 **Mounting place** — Place the unit:
 - on a flat, even surface
 - away from strong magnetic fields
 - at least one meter away from any radios or receivers
 Do not place heavy objects on the unit.

- 4 **Ventilation** — The unit should be situated with adequate space around it so that proper heat ventilation is assured. Allow a clearance of 10 cm (4 in.) from the rear and the top of the unit, and 5 cm (2 in.) from each side.
 - Do not place the unit on a bed, rug, or similar surface that may block the ventilation openings.
 - Do not install the unit in a bookcase, cabinet, or airtight rack where ventilation may be impeded.
 - To avoid internal heat build-up, do not cover the ventilation openings on the rear panel.
- 5 **Foreign objects and liquid** — Be careful that foreign objects or liquid do not enter the unit through the ventilation openings.
- 6 **Carts and stands** — The unit should be moved with care when placed or mounted on a stand or cart. Sudden stops, excessive force, or an uneven surface may cause the unit or cart to fall over. 
- 7 **Condensation** — Moisture may form on the pickup lens when:
 - This unit is moved from a cold spot to a warm spot
 - A heating system has just been turned on
 - The unit is used in a very humid room
 - The unit is cooled by an air conditioner
 When this unit has condensation inside, it may not function normally. Should this occur, leave the unit for a few hours, then try to operate again.

Electric power

- 1 **Power sources** — Connect this unit only to power sources specified in the Operating Instructions, and as marked on the unit.
- 2 **AC power cord**
 - When disconnecting the AC power cord, pull it out by the AC power plug. Do not pull the cord itself.
 - Never handle the AC power plug with wet hands, as this could result in fire or electrical shock.
 - Power cords should be firmly secured to avoid being severely bent, pinched, or walked upon. Pay particular attention to the cord from the unit to the power socket.
 - Avoid overloading AC power plugs and extension cords beyond their capacity, as this could result in fire or electrical shock.
- 3 **When not in use** — Unplug the AC power cord from the AC outlet if the unit will not be used for several months or more. When the cord is plugged in, a small electrical current continues to flow into the unit, even if the power is turned off.
- 4 **In case of lightning** — Immediately disconnect the AC power cord from the AC outlet.

Maintenance

Clean the unit only as recommended in the Operating Instructions.

Damage requiring service

Have this unit serviced by a qualified service technician if:

- The AC power cord or plug has been damaged
- A foreign object or liquid has entered the unit
- The unit has been exposed to rain or water
- The unit does not seem to operate normally
- The unit exhibits a marked change in performance
- The unit has been dropped, or the cabinet has been damaged

DO NOT OPEN THE CABINET AND ATTEMPT TO SERVICE THE UNIT YOURSELF.

TABLE OF CONTENTS

Introduction

Precautions	2
Before use	4
About symbols	4
Supported disc formats	4
Disc-related terms	5
Notes on copyright	5
Handling discs	6
Cleaning discs	6
Storing discs	6
Handling the unit	6
Cleaning the unit	6
Remote control	7
Parts and controls	8
Front panel	8
Remote control	9
Display window	10

Preparations

Connections	11
A Connecting to a TV only	12
B Connecting to a TV and an amplifier with a Digital In jack	13
C Connecting to a TV and an audio system	14
D Connecting to a TV and an AV receiver equipped with a Dolby Digital (AC-3) decoder	15
E Connecting to a TV and an AV receiver equipped with a DTS decoder	16
F Connecting to a TV and an AV receiver with the Dolby Pro Logic Surround system	17
Connecting to a TV equipped with an S-video jack	18
Connecting to a TV or monitor with component video input connectors	19

Basic Operations

Playback	20
Still (Pause)	21
Frame advance	21
Resuming playback	21
Fast forward and reverse	22
Slow playback	22
Skipping	22
Muting the sound	22
On Screen Display (OSD) menu	23
Detailed description of each OSD menu	24

More Features

Search	26
Title search	26
Chapter/track search	27
Time search	27
Mark search	28
Zooming and changing the angle	29
Zooming the picture	29
Changing the angle	29

Random and repeat playback	30
Random playback	30
Repeat playback	30
Repeating a portion between two specified points (A-B Repeat)	31
Programmed playback	32
Disabling OSD	33
Changing the audio track	34
Displaying and changing subtitles	35
Playing back an MP3 disc	36
Notes on MP3 discs	36
Glossary	36
Playing back an MP3 disc	37
Editing the MP3 Song Selection List	37
Using the command box	38

As Necessary

Changing setup values	40
Basic operations	40
Language	41
Subtitle	42
TV aspect	42
Audio set	44
Digital out	45
Parental	46
On screen	47
Troubleshooting	48
Specifications	49

Features

DVD provides a completely new dimension in video entertainment.

- **Multi-language function***: You can select audio soundtracks and subtitles.
- **Multi-angle function***: You can select a viewing angle of scenes shot from multiple camera angles and recorded on the disc.
- **Parental lock function***: You can prevent playback of specified discs unsuitable for certain audiences.

* These functions differ depending on the DVD software.

High quality digital audio and images

- **The linear PCM sound of a 96 kHz/24 bit** creates audio quality superior to that of audio CDs.
- **Compatible with audio CDs, as well as DVDs**
- **MP3 playback**

Accessory checklist

Remote control (1)
 Battery (installed in the remote control) (1)
 Audio/Video cord (1)
 Operating Instructions

BEFORE USE

Please read the following before operating the unit.

About symbols

Although this unit can play DVDs, audio CDs or MP3 discs, some of the functions are restricted dependent on the type of disc.

The following symbols are used to make distinction. Playback of MP3 discs is different from that of other kinds of discs. For information about playing back MP3 discs, see page 36.

- DVD** : Shows the function or the display for only DVDs.
- CD** : Shows the function or the display for only audio CDs.

No symbols: The function works for DVDs and audio CDs.

Supported disc formats

This unit can play discs with the following marks only.

	DVD (8 cm disc/12 cm disc)
	Audio CD (8 cm disc/12 cm disc)

This unit can play a DVD-R recorded in Video mode. In addition, this unit can play a CD-R or CD-RW that contains audio titles or MP3 files.

NOTES

- The unit can play DVD-R discs recorded in Video mode only. DVD-R discs recorded in VR (Video Recording) mode cannot be played on the unit.
- Depending on the conditions of the recording equipment, some DVD-R discs cannot be played on the unit even if they have been recorded in Video mode.
- Some DVD-R discs cannot be played on the unit due to scratches on the surface or warp, etc.
- Depending on the conditions of the recording equipment or the CD-R/RW disc itself, some CD-R/RW discs cannot be played on the unit.
- The unit cannot play the CD-R/RW discs that contain no data, or contain different kinds of formatted data other than MP3.
For more information about MP3, see page 36.
- Do not attach any seal or label to either side (the labeled side or the recorded side) of a disc.
- Do not use irregular shaped CDs (e.g., heart-shaped or octagonal). It may result in malfunctions.

Notes on color format

The materials for DVD discs are recorded in the PAL and NTSC color format.

Select DVDs recorded in NTSC color format.

Notes on DVDs

Some playback operations of DVDs may be intentionally fixed by software manufacturers. As this unit plays DVDs according to disc content designed by the software manufacturer, some playback features of the unit may not be available, or other functions may be added.

Refer also to the instructions supplied with the DVDs.

Some DVDs made for business purposes may not be played on the unit.

Region code of the DVD player and DVDs



This DVD player is designed and manufactured for playback of region "1" encoded DVD software. The region code on the labels of some DVD discs indicates which type of player can play those discs. This unit can play only DVD discs labeled "1" or "ALL". If you try to play any other discs, the message "Invalid region disc" will appear on the TV screen. Some DVD discs may not have a region code label even though their playback is prohibited by area limits.

Note on DTS-encoded CDs

When playing DTS-encoded CDs, excessive noise will be exhibited from the analog stereo outputs. To avoid possible damage to the audio system, turn down the volume before playing back such discs, adjust the volume gradually, and keep the volume level low. To enjoy DTS Digital Surround™ playback, an external 5.1 channel DTS Digital Surround™ decoder system must be connected to the digital output of the unit.

Disc-related terms

Title (DVD only)

The longest section of a picture or a musical piece on a DVD, a movie for a picture piece on video software, or an album for a musical piece on audio software. Each title is assigned a title number enabling you to locate the title you want.

Chapter (DVD only)

Sections of a picture or a musical piece that are smaller than titles.

A title is composed of several chapters. Each chapter is assigned a chapter number, enabling you to locate the chapter you want. Depending on the disc, no chapters may be recorded.

Track (audio CD only)

Sections of a musical piece on an audio CD. Each track is assigned a track number, enabling you to locate the track you want.

Notes on copyright

It is forbidden by law to copy, broadcast, show, broadcast via cable, play in public, or rent copyright material without permission.

This product features the copy protection function developed by Macrovision. Copy protection signals are recorded on some discs. When recording and playing the pictures of these discs on a VCR, the picture noise will appear.

This product incorporates copyright protection technology that is protected by method claims of certain U.S. patents and other intellectual property rights owned by Macrovision Corporation and other rights owners. Use of this copyright protection technology must be authorized by Macrovision Corporation, and is intended for home and other limited viewing uses only unless otherwise authorized by Macrovision Corporation. Reverse engineering or disassembly is prohibited.

BEFORE USE (CONTINUED)

Handling discs

Do not touch the playback side of the disc.
Hold the disc by the edges so that fingerprints will not get on the surface.
Do not stick paper or tape on the disc.

Cleaning discs

Fingerprints and dust on the disc can cause poor picture quality and sound distortion. Before playing, clean the disc with a clean cloth. Wipe the disc from the center out.

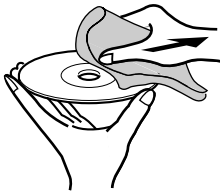

Do not use strong solvents such as alcohol, benzene, thinner, commercially available cleaners, or anti-static spray intended for analog records.

Storing discs

After playing, store the disc in its case.
Do not expose the disc to direct sunlight or sources of heat, or leave it in a parked car exposed to direct sunlight, as there may be a considerable temperature increase inside the car.

Handling the unit

When shipping the unit

The original shipping carton and packing materials come in handy. For maximum protection, re-pack the unit as it was originally packed at the factory.

When setting the unit

The picture and sound of a nearby TV, VCR, or radio may be distorted during playback. In this case, position the unit away from the TV, VCR, or radio, or turn off the unit after removing the disc.

To keep the surface clean

Do not use volatile liquids, such as insecticide spray, near the unit. Do not leave rubber or plastic products in contact with the unit for a long period of time. They will leave marks on the surface.

Cleaning the unit

To clean the cabinet

Use a soft, dry cloth. If the surfaces are extremely dirty, use a soft cloth lightly moistened with a mild detergent solution. Do not use strong solvents, such as alcohol, benzene, or thinner, as these might damage the surface of the unit.

To obtain a clear picture

The DVD player is a high-tech, precision device. If the optical pick-up lens and disc drive parts are dirty or worn down, the picture quality will be poor. Regular inspection and maintenance are recommended after every 1,000 hours of use. (This depends on the operating environment.) For details, please contact your Aiwa dealer.

REMOTE CONTROL

Before using the remote control

A battery (CR2025) is already installed in the remote control when shipped from the factory .

Remove the insulating tape from the battery holder by pulling its end as shown below .

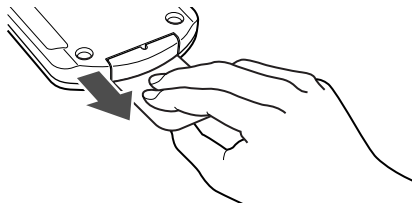

When to replace the battery

The maximum operating distance between the remote control and the remote sensor of the unit is approximately 7 meters. If the operating range decreases, replace the battery with a new one.

How to replace the battery

Insert a ballpoint pen or similar pointed tool in the notch of the battery holder at the bottom, and then slide out the battery holder . Place a new battery (CR2025) into the battery holder with correct polarity . Finally , push the holder back into position.

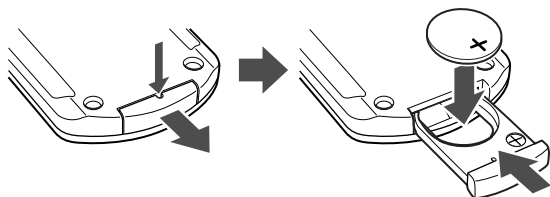

NOTES

- When operating with the remote control, point the top of the remote control toward the DVD player .
- If the unit is not going to be used for an extended period of time, remove the battery to prevent possible electrolyte leakage.
- The remote control may not operate correctly when:
 - There is an intense light, such as sunlight, in the line of sight between the remote control and the DVD player .
 - There is fluorescent lighting near the remote sensor .
 - Other remote controls are used nearby (those of a TV set, etc.).

CAUTION

- **Lithium battery (CR2025) for the remote control**
Replace the battery with Hitachi Maxell or Panasonic, Part No. CR2025 only . Use of another battery may present a risk of fire or explosion.
The battery may explode if mistreated. Do not recharge, disassemble or dispose of in fire.
- Do not keep metallic objects such as rings, bracelets, and keys near the battery . They may cause the battery to short circuit.
- After removing the battery , be sure to keep it out of reach of children. If it is swallowed, consult a doctor immediately .

PARTS AND CONTROLS

The instructions in this manual refer mainly to the buttons on the remote control. Buttons on the main unit with the same names as those on the remote control can be used as well.

Front panel

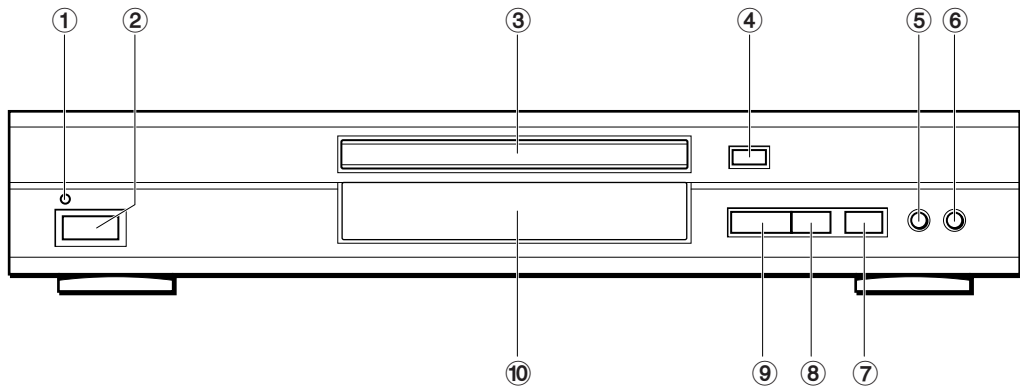

- ① **STANDBY** indicator
Lights in red when the unit is in standby mode.
- ② **POWER** button
Press to turn on and off the unit.
- ③ **Disc tray**
Loading and removing discs.
- ④ **▲ OPEN/CLOSE** button
Press to open and close the disc tray.
- ⑤ **◀◀** button
Press to return to the beginning of the current or previous chapter/track.
- ⑥ **▶▶** button
Press to skip to the next chapter/track.
- ⑦ **|| PAUSE** button
Press to pause playback.
- ⑧ **■ STOP** button
Press to stop playing back a disc.
- ⑨ **▶ PLAY** button
Press to start playback.
- ⑩ **Display window**
Displays the information of the unit's status.

Remote control

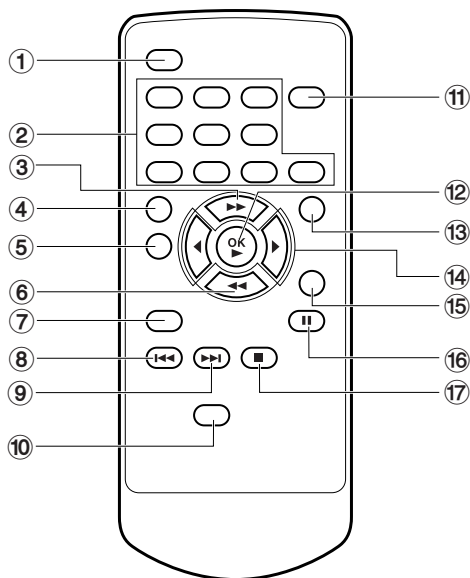

- ① **POWER** button
Press to turn on and off the unit.
- ② **Number** buttons
Press to select a track or title directly .
- ③ **▶▶** buttons
 - Press to fast forward a disc.
 - Press to select an item in the setup menu.
- ④ **TOP MENU** button **DVD**
Press to display the title menu if present on the disc.
- ⑤ **MENU** button
DVD
 - Press to display the disc menu during play .
 - Press to display the setup menu in stop mode.
- ⑥ **◀◀** button
 - Press to fast reverse a disc.
 - Press to select an item in the setup menu.
- ⑦ **AUDIO** button
DVD
 - Press to display the language/sound menu icon.**CD**
 - Press to display the program menu.
- ⑧ **I◀◀** button
Press to return to the beginning of the current or previous chapter/track.
- ⑨ **▶▶I** button
Press to skip to the next chapter/track.
- ⑩ **MUTE** button
Press to mute and unmute the sound.
- ⑪ **MARK** button **DVD**
Press to display the mark menu during play .
- ⑫ **OK ▶** button
 - Press to start playback.
 - Press to confirm the selected item in the setup menu.
- ⑬ **ON SCREEN** button
Press to enter and exit from the On Screen Display .
- ⑭ **◀/▶** buttons
 - Press ▶ to slow forward a disc. Press ◀ to slow reverse a disc.
 - Press to navigate through the On Screen Display , or change the value in the setup menu.
- ⑮ **EXIT** button
Press to exit from menus or On Screen Display .
- ⑯ **||** button
Press to pause playback.
- ⑰ **■** button
Press to stop playing back a disc.

CONTINUE

PARTS AND CONTROLS (CONTINUED)

Display window

This unit shows On Screen Display messages on the screen of the TV connected to the unit, as well as the display window of the unit.

The On Screen Display of each operation makes operation simple and easy, especially when playing DVDs. They appear when you press the ON SCREEN button on the remote control.

The instructions in this manual refer mainly to the On Screen Display messages.

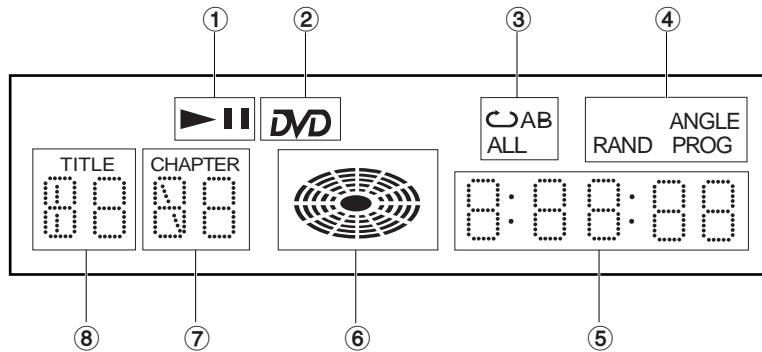

- ① **▶** indicator
Lights in playback mode.
|| indicator
Lights in pause mode.
- ② **DVD** indicator **DVD**
Lights when a DVD is loaded.
- ③ **↺** **A-B** indicator
Indicates A-B repeat play mode (when playing a desired portion of a track repeatedly).
CD
↺ **ALL** indicator
Indicates all track repeat play mode.
CD
↺ indicator
Indicates one track repeat play mode.
- ④ **ANGLE** indicator **DVD**
Lights when a multi-angle scene is played.
RAND indicator **CD**
Lights during random playback.
PROG indicator **CD**
Lights during programmed playback.
- ⑤ **Time** counter
 - Indicates the elapsed time of the chapter or track.
 - Indicates the total playing time of a CD, in stop mode. (The total playing time is not displayed when other kinds of discs stopped.)
- ⑥ **Operating status** indicator
Rotates when loading and playing back a disc.
- ⑦ **CHAPTER** indicator **DVD**
 - Indicates the chapter number being played during DVD playback.**CD**
 - Indicates a total number of tracks in stop mode, or the track number being played during playback of a CD.
- ⑧ **TITLE** indicator **DVD**
Indicates the title number being played during DVD playback.

CONNECTIONS

Before connecting, identify your type of audio equipment or the setup procedure accordingly .

TV referring to the following chart.

Then, decide the connection

NOTES

- The unit cannot be connected to a TV which is not equipped with a video input connector .
- Use a commercially available stereo-monaural audio cord when connecting to a monaural TV.

Audio system to be connected	Input jack of equipment to be connected to the unit	Connection type
None (only a TV is connected)	—	A on page 12
A stereo system or an amplifier	Digital input jack	B on page 13
	Analog audio input jacks (L/R)	C on page 14
An AV receiver equipped with Dolby Digital decoder or a Dolby Pro Logic decoder	Digital input jack	D on page 15
	Analog audio input jacks (L/R)	F on page 17
An AV receiver equipped with DTS decoder	Digital input jack	E on page 16

When your TV is equipped with an S-video input jack, see page 18.

When your TV is equipped with component video input jacks, see page 19.

Before making connections

- Connect the AC cords of the unit and any external equipment last, after finishing all other connections.
- Insert the plugs completely into the jacks. Loose connections may produce a humming sound or other noise interference.
- Refer to the instructions of the connected equipment.

NOTES

- If picture noise appears while playing copy-protected DVDs, connect the unit directly to a TV. Do not connect through a VCR, TV/VCR, or AV selector .
- For speaker connection, refer to the instructions of the AV receiver .

CAUTION

Do not set "Dolby Digital" to "Bitstream", and "DTS" to "Bitstream" in the setup menu when connecting to an AV receiver not equipped with a Dolby Digital decoder or DTS decoder (with a coaxial connecting cord).

Merely attempting to play a DVD may cause a screeching noise which could be harmful to your ears and damage the speakers. In such a case, be sure to select "PCM" in "Digital Out".

CONNECTIONS (CONTINUED)

A Connecting to a TV only

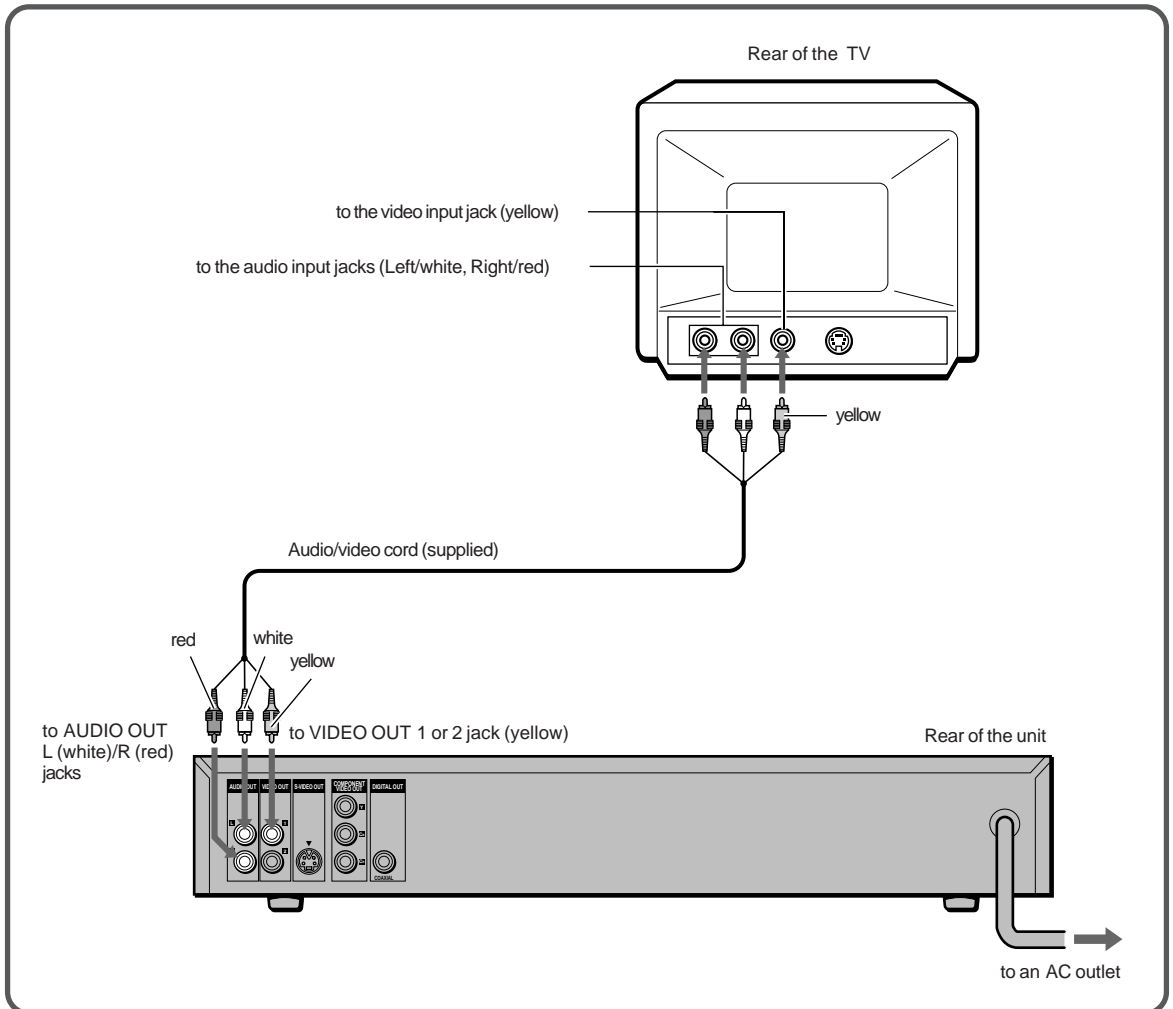

Set the setup menu correctly after connecting!

Set the "TV Aspect" of the setup menu according to the TV connected to the unit as follows:
(See "CHANGING SETUP VALUES" on page 40 for details.)

TV Aspect

When your TV is a conventional-screen size TV:
L-BOX or P-SCAN

When your TV is a wide-screen size TV:
16:9

Connecting to a TV and an amplifier with a Digital In jack

Use a commercially available 75 ohm coaxial cord when connecting the unit to an AV amplifier with a Digital In jack. The supplied Audio/video cord is also available instead of a coaxial cord.

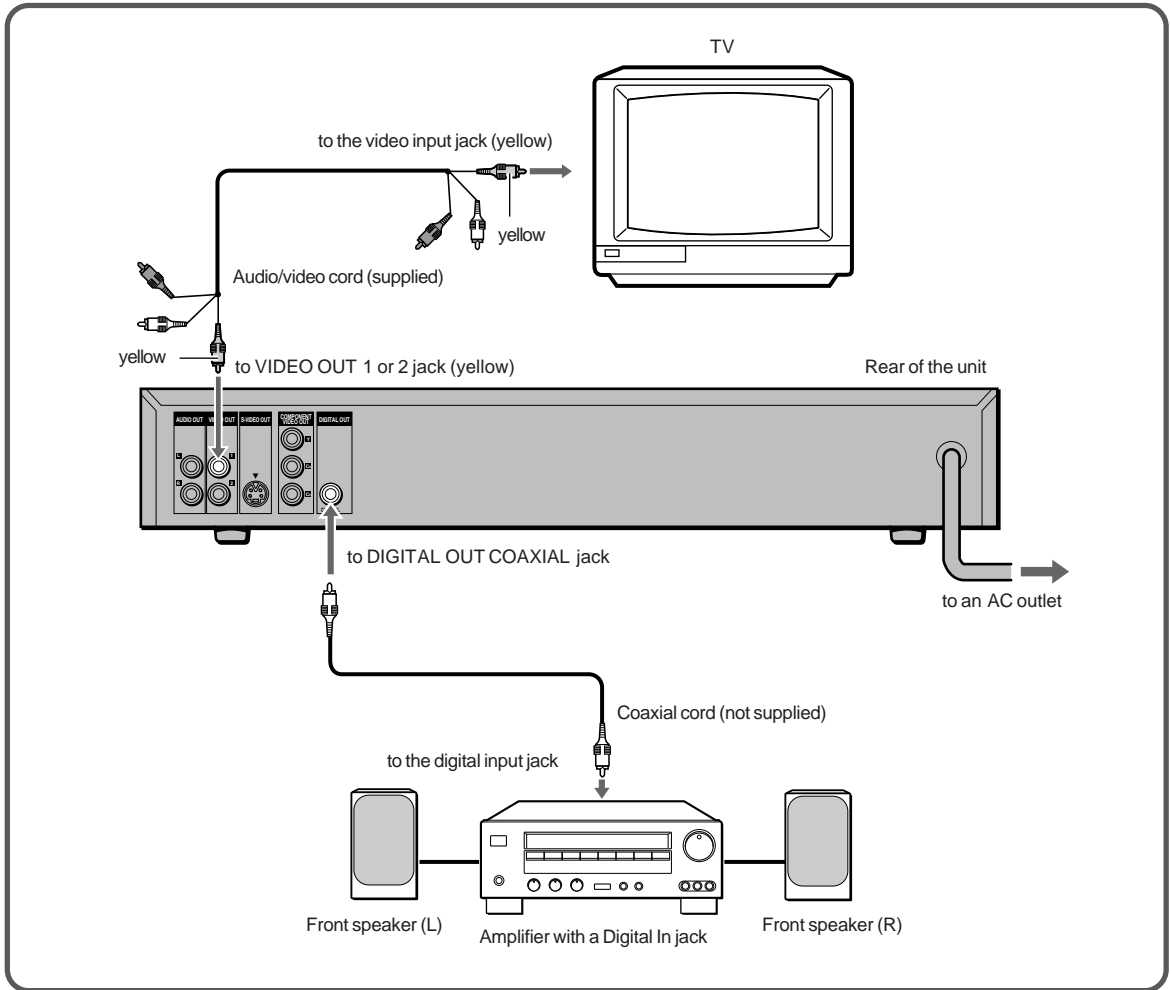

Set the setup menu correctly after connecting!

Set the "TV Aspect" and "Digital out" of the setup menu according to the audio equipment and TV connected to the unit as follows:
(See "CHANGING SETUP VALUES" on page 40 for details.)

Digital out

"Dolby Digital" to "PCM"
"DTS" to "Off"

TV Aspect

When your TV is a conventional-screen size TV:
L-BOX or P-SCAN
When your TV is a wide-screen size TV:
16:9

CONTINUE

CONNECTIONS (CONTINUED)

Connecting to a TV and an audio system

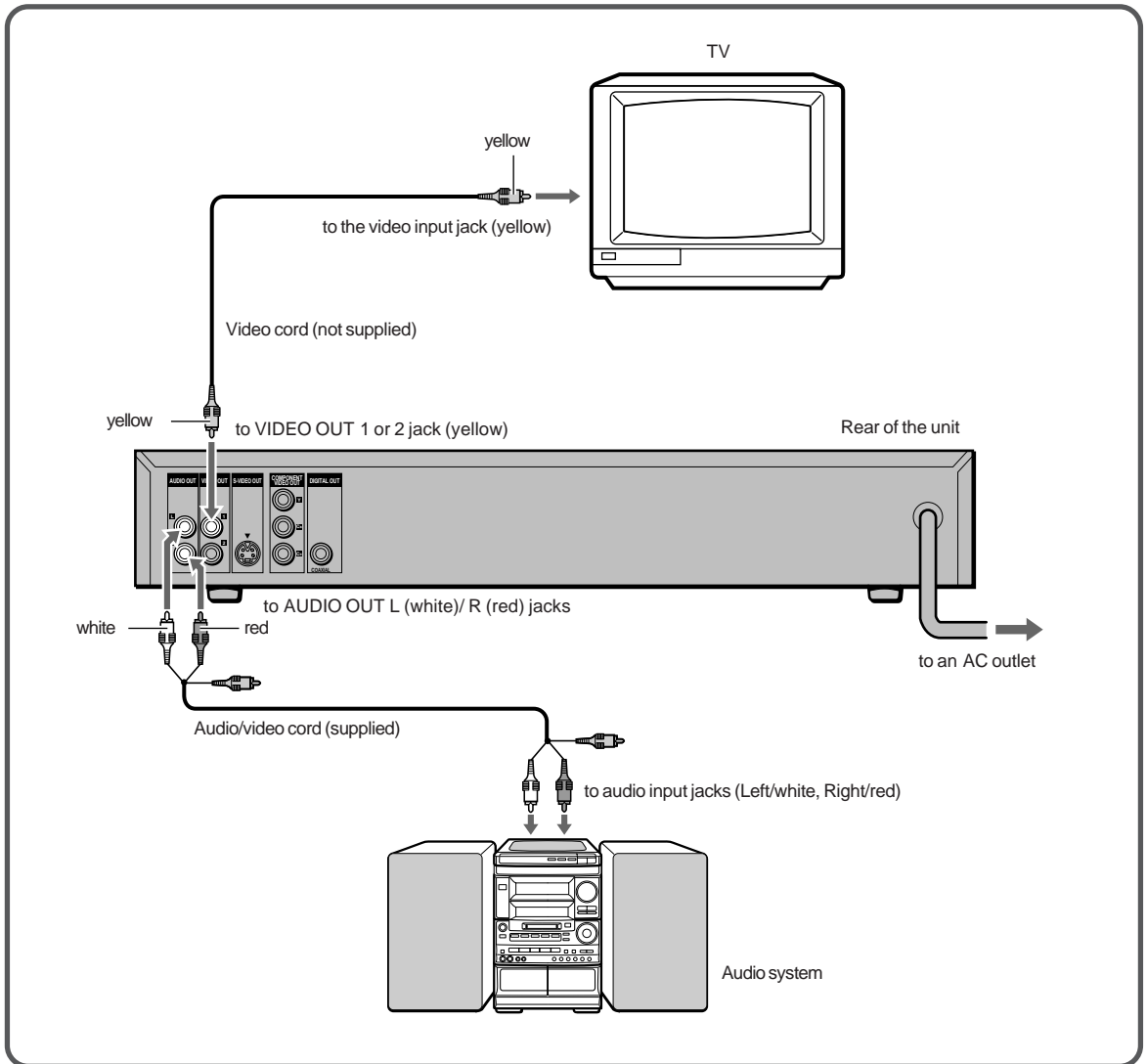

Set the setup menu correctly after connecting!

Set the "TV Aspect" of the setup menu according to the TV connected to the unit as follows:
(See "CHANGING SETUP VALUES" on page 40 for details.)

TV Aspect

When your TV is a conventional-screen size TV:
L-BOX or P-SCAN

When your TV is a wide-screen size TV:
16:9

D Connecting to a TV and an AV receiver equipped with a Dolby Digital (AC-3) decoder

Use either a commercially available optical cord or a 75 ohm coaxial cord when connecting this unit to an AV receiver with a Digital In jack. The supplied Audio/video cord is also available instead of a coaxial cord.

AV receiver with

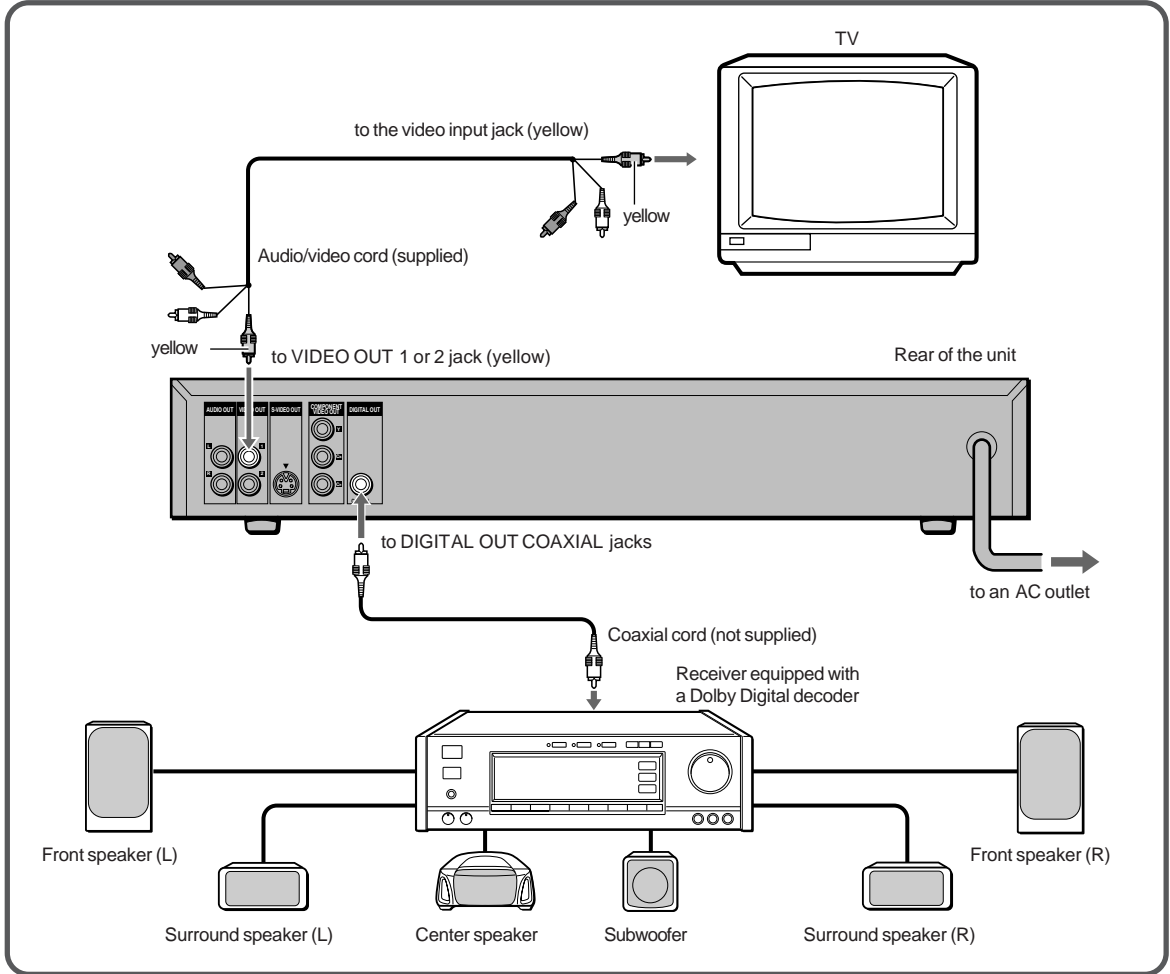

Set the setup menu correctly after connecting!

Set the "TV Aspect" and "Digital out" of the setup menu according to the audio equipment and TV connected to the unit as follows:
(See "CHANGING SETUP VALUES" on page 40 for details.)

Digital out

"Dolby Digital" to "Bitstream"
"DTS" to "Off"

TV Aspect

When your TV is a conventional-screen size TV:
L-BOX or P-SCAN

When your TV is a wide-screen size TV:
16:9

CAUTION

When connecting an AV receiver not equipped with a Dolby Digital decoder using a coaxial connecting cord, **do not set "Dolby Digital" to "Bitstream"** in "Digital out" of the setup menu.

Merely attempting to play a DVD may cause a screeching noise which could be harmful to your ears and damage the speakers. In such a case, be sure to set "Dolby Digital" to "PCM" in "Digital Out".

CONNECTIONS (CONTINUED)

Connecting to a TV and an AV receiver equipped with a DTS decoder

Use a commercially available 75 ohm coaxial cord when connecting the unit to an AV receiver with a Digital In jack. The supplied Audio/video cord is also available instead of a coaxial cord.

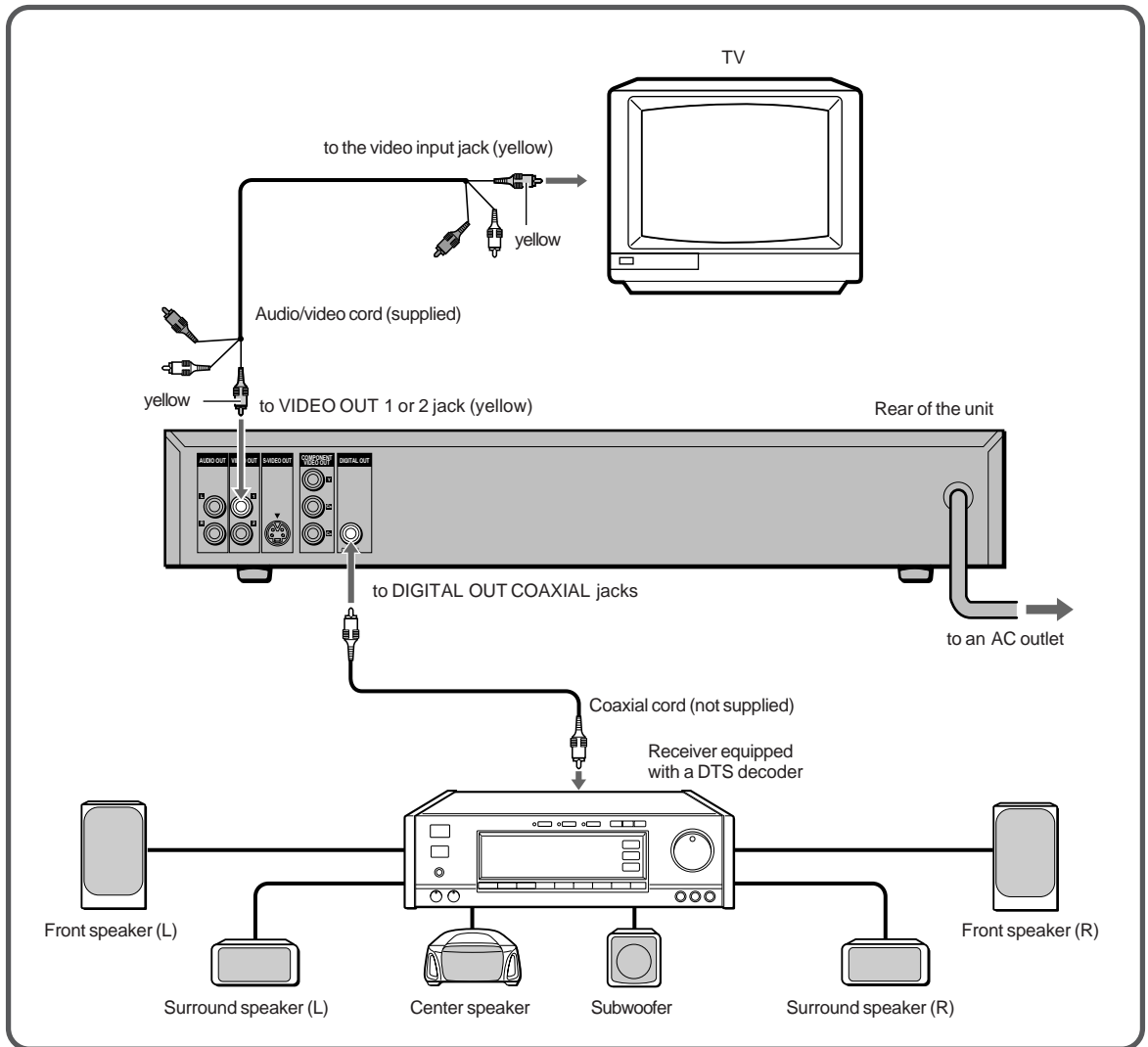

Set the setup menu correctly after connecting!

Set the "TV Aspect" and "Digital out" of the setup menu according to the audio equipment and TV connected to the unit as follows:
(See "CHANGING SETUP VALUES" on page 40 for details.)

Digital out

"Dolby Digital" to "PCM"
"DTS" to "Bitstream"

TV Aspect

When your TV is a conventional-screen size TV:
L-BOX or P-SCAN
When your TV is a wide-screen size TV:
16:9

CAUTION

When connecting an AV receiver not equipped with a DTS decoder using a coaxial connecting cord, **do not set "DTS" to "Bitstream"** in "Digital out" of the setup menu. Merely attempting to play a DVD may cause a screeching noise which could be harmful to your ears and damage the speakers. In such a case, be sure to set "DTS" to "Off" in "Digital Out".

Connecting to a TV and an AV receiver with the Dolby Pro Logic Surround system

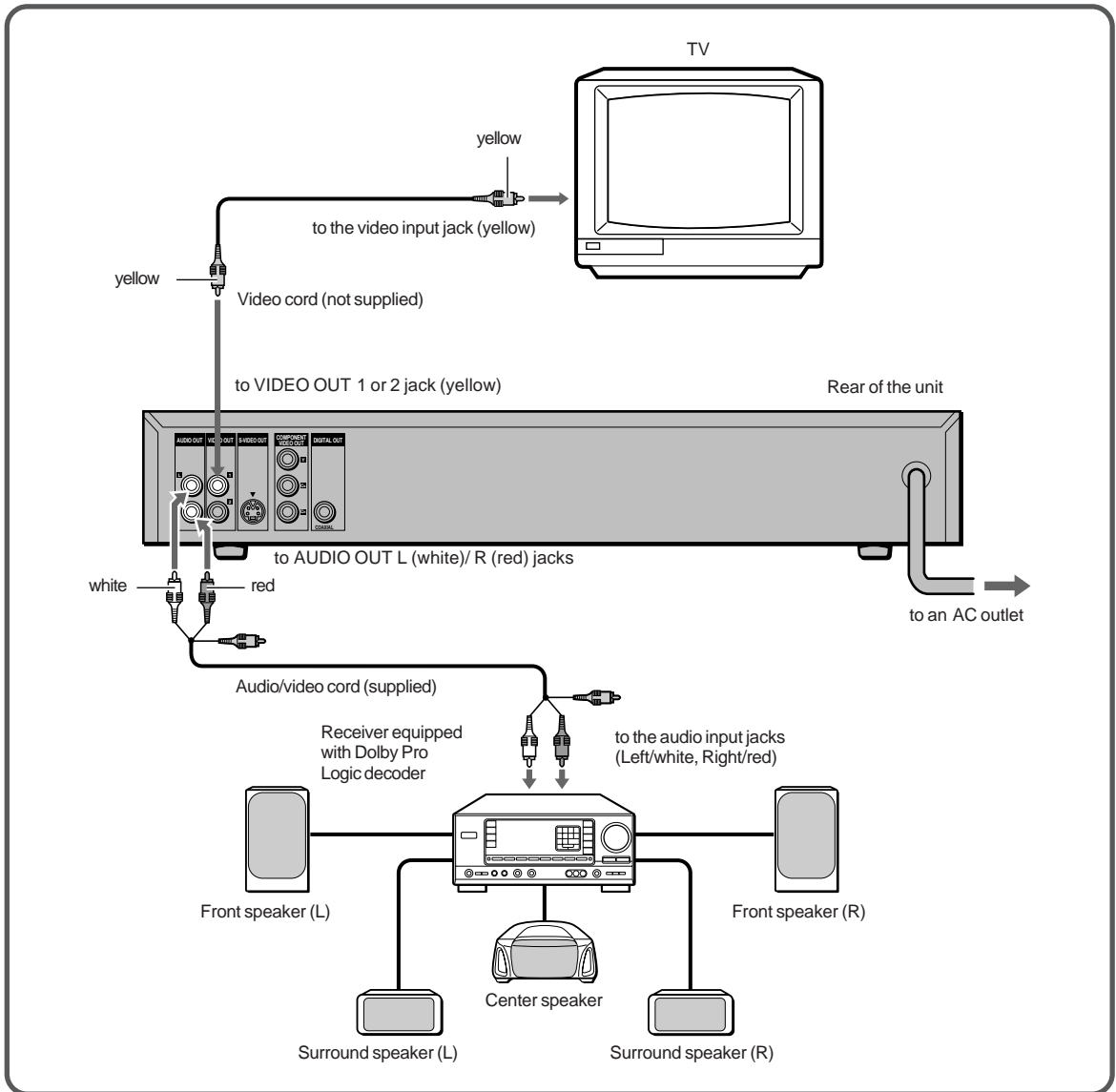

Set the setup menu correctly after connecting!

Set the "TV Aspect" and "Digital out" of the setup menu according to the audio equipment and TV connected to the unit as follows:
(See "CHANGING SETUP VALUES" on page 40 for details.)

Digital out

"Dolby Digital" to "Bitstream"
"DTS" to "Off"

TV Aspect

When your TV is a conventional-screen size TV:
L-BOX or P-SCAN
When your TV is a wide-screen size TV:
16:9

CONTINUE

CONNECTIONS (CONTINUED)

Connecting to a TV equipped with an S-video jack

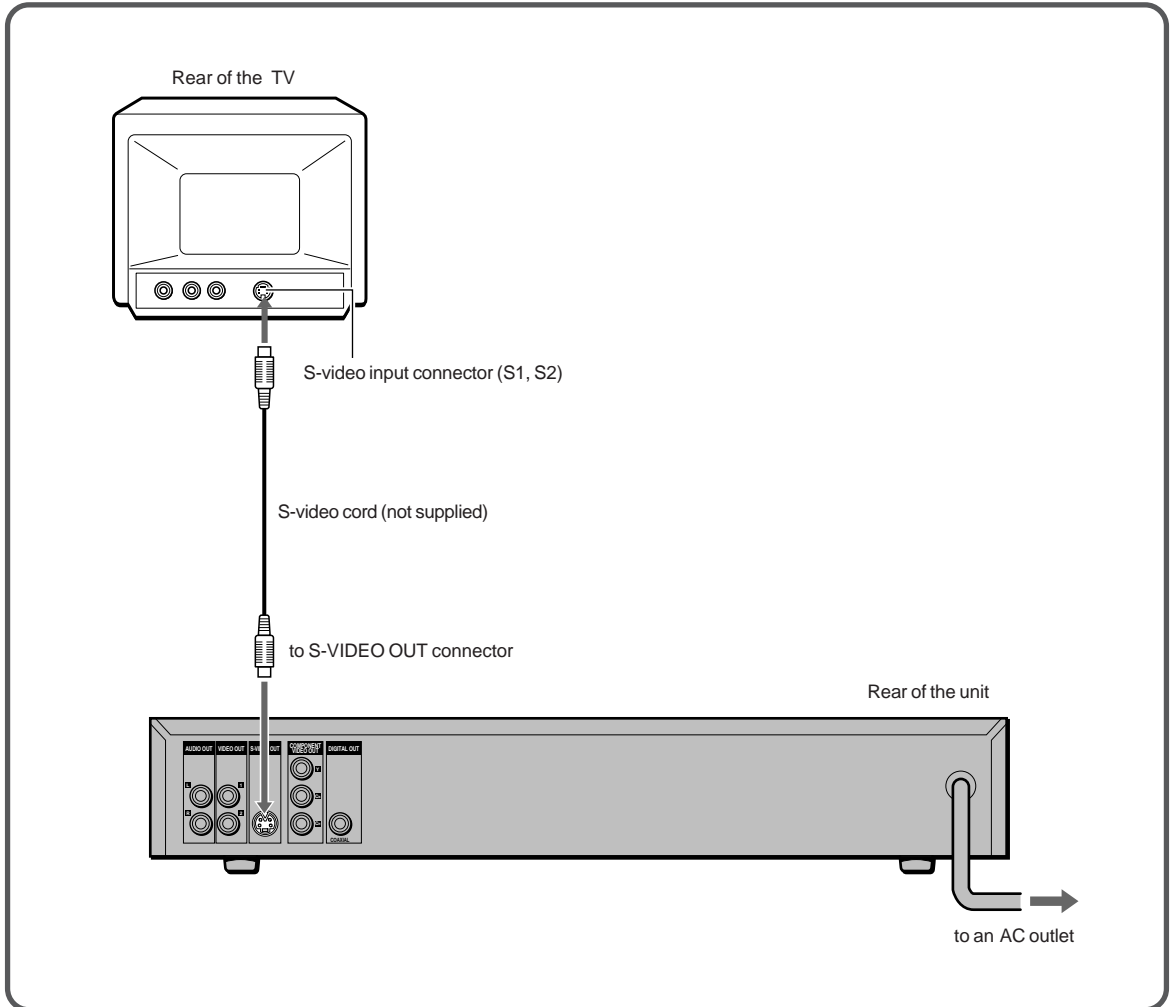

Set the setup menu correctly after connecting!

Set the "TV Aspect" of the setup menu according to the TV connected to the unit as follows:
(See "CHANGING SETUP VALUES" on page 40 for details.)

TV Aspect

When your TV is a conventional-screen size TV:
L-BOX or P-SCAN

When your TV is a wide-screen size TV:
16:9

NOTE

For the best possible picture clarity, it is recommended that an S (separate) video cord (not supplied) be used when connecting the unit to a TV equipped with an S-video input terminal.

Connecting to a TV or monitor with component video input connectors

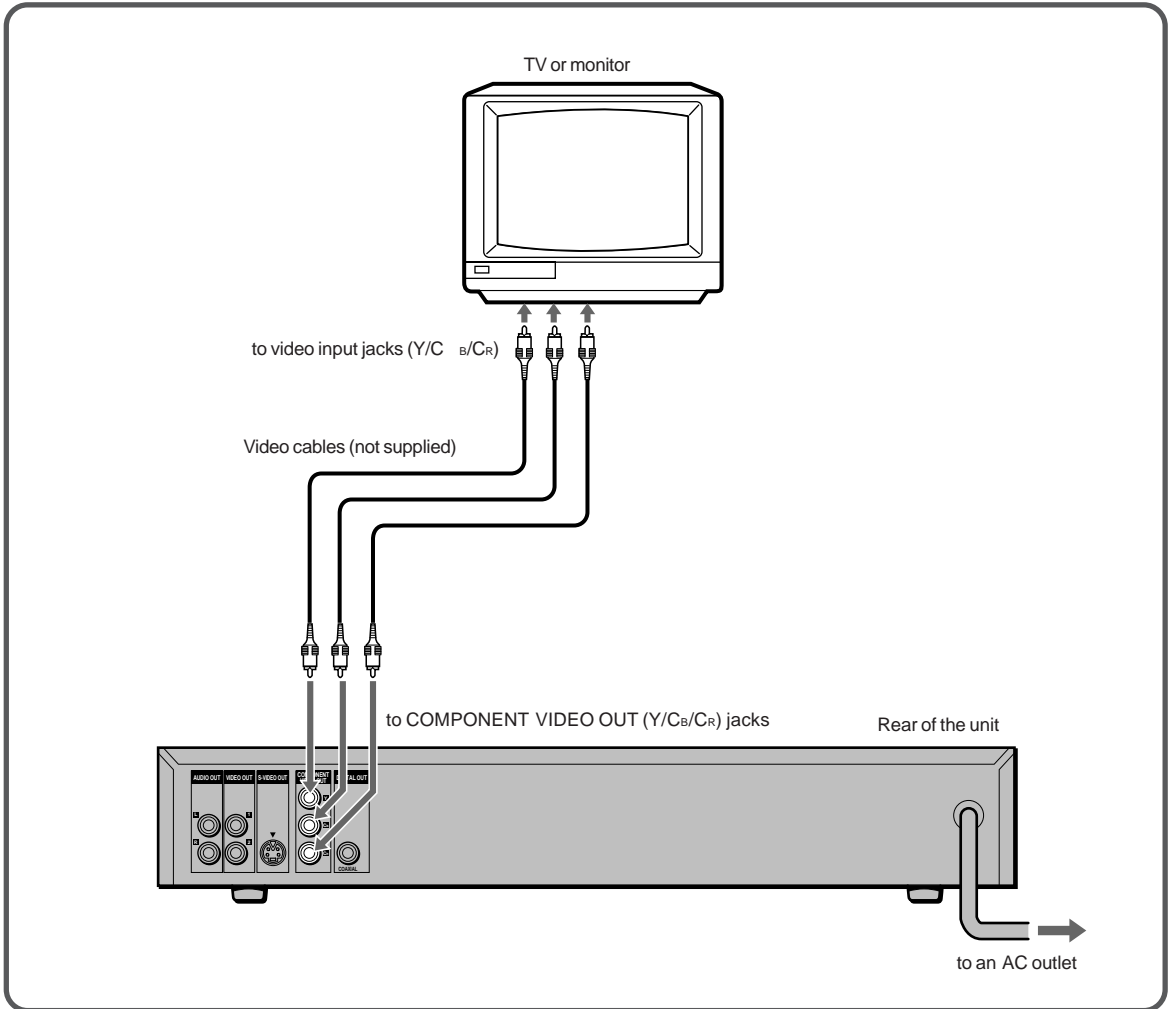

Component video output jacks (C_B/C_R/Y)

The component video output jacks output the different color signals (C_B/C_R) and luminance signal (Y) separately in order to achieve high fidelity in reproducing colors.

The description of the component video output connectors may differ depending on the connected TV or monitor (e.g. P_B/P_R/Y, C_B/C_R/Y, B-Y/R-Y/Y, etc.). Refer to the operating instructions of the TV for details.

Set the setup menu correctly after connecting!

Set the "TV Aspect" of the setup menu according to the TV connected to the unit as follows: (See "CHANGING SETUP VALUES" on page 40 for details.)

TV Aspect

When your TV is a conventional-screen size TV:
L-BOX or P-SCAN

When your TV is a wide-screen size TV:
16:9

PLAYBACK

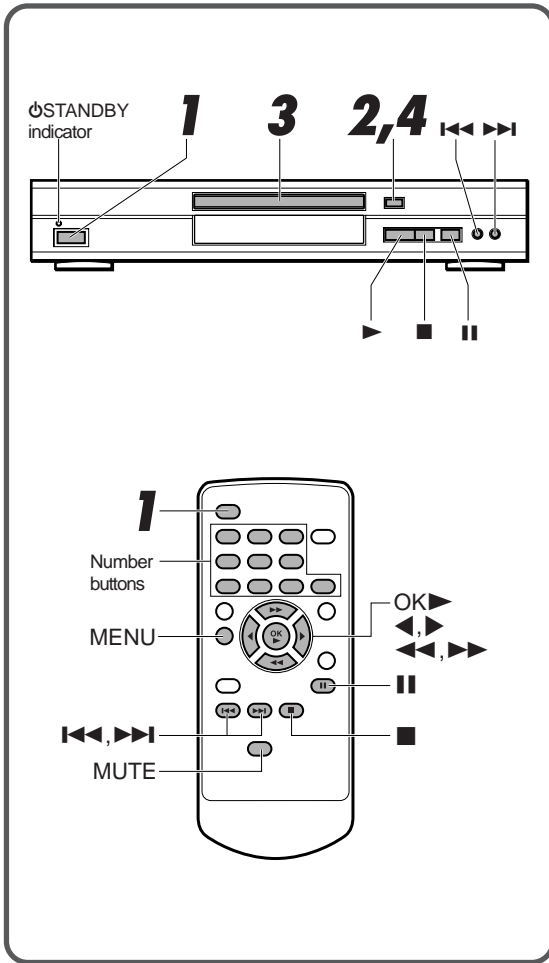

Getting ready to play

- Turn on the TV, and set its video source (Video 1, Video 2, Video 3, etc.) to the one connected to the unit.
- Turn on the audio equipment connected to the unit. Set its input source to the one connected to the unit.

1 Press POWER.

The unit turns on and the STANDBY indicator turns off. The " **awa** " screen appears on the TV screen.

2 Press OPEN/CLOSE.

The disc tray opens.

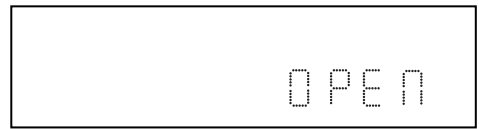

3 Load a disc.

Place a disc in the tray guides (depressed area) with the label side facing up. When loading an 8-cm disc, place it in the inner depression.

4 Press OPEN/CLOSE.

The disc tray closes, and the unit automatically starts playing the disc.

If playback does not start, press OK .

About the symbol display

- The symbol will be displayed on the TV screen if you press a button which cannot be used or enter an incorrect number.
- Some DVD discs may have places where pressing of the STOP, SKIP, or other buttons is not allowed. The mark will be displayed on the TV screen if you press a button that is not allowed in such a place.

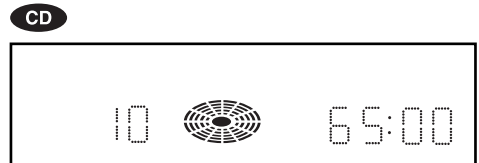
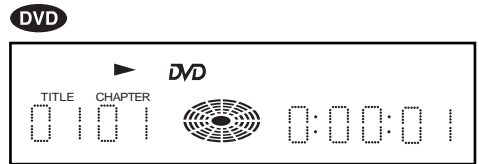

When the menu screen is displayed

DVD

The menu screen may be displayed first after loading a DVD which contains a menu.

Use the ◀/▶/◀◀/▶▶ buttons to select the title/chapter you want to view, then press **OK ▶** to start playback. Press **TOP MENU** or **MENU** to return to the menu screen.

To stop playback

Press **■**.

To turn the power off

Press **POWER** on the remote control. The unit enters power standby mode and the **STANDBY** indicator turns red.

If the unit is left for 20 minutes without any operations

The unit automatically enters standby mode.

NOTE

The disc continues to spin while the menu screen is displayed. When you are finished using the unit, turn the power of f after pressing **■**.

Still (Pause)

Press **⏸** during playback.

To return to normal playback

Press **OK ▶**.

CD

You can also press **⏸** to return to normal playback.

Frame advance

DVD

Press **⏸** during pause.

Each time you press the button, the program advances one frame. There is no audio during Frame Advance playback.

To return to normal playback

Press **OK ▶**.

Resuming playback

The unit remembers the point where you stopped the disc and you can resume playback from that point.

Press **OK ▶** in stop mode.

To clear the resume point

Press **■** again after you stop the disc.

The resume point is also cleared when you press **▲ OPEN/CLOSE** to open the disc tray, or **POWER** to turn the power off.

PLAYBACK (CONTINUED)

Fast forward and reverse

Press **▶▶** or **◀◀** during playback.

There are 4 speeds for DVD and 3 speeds for audio CD. Each press increases the speed as shown below.

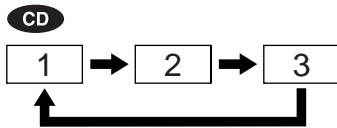
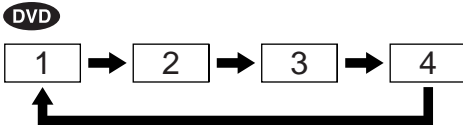

To return to normal playback

Press **OK ▶**.

NOTE

There is no audio during DVD playback.

Slow playback

DVD

Press **▶** or **◀** during playback.

There are 4 speeds and each press reduces the speed as shown below.

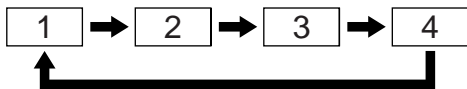

To return to normal playback

Press **OK ▶**.

NOTES

- There is no audio during slow playback.
- Subtitles do not appear on the TV screen during slow playback.

Skipping

Press **I◀◀** or **▶▶I**.

To skip to the next chapter or track: ▶▶I

The disc position advances one chapter or track each time the button is pressed.

To return to the previous chapter or track: I◀◀

I◀◀

Pressing **I◀◀** once skips to the beginning of the chapter (track) currently being played, and pressing **I◀◀** twice skips to the previous chapter (track).

To skip to the desired track directly using the number buttons

CD

During playback or in stop mode, enter the desired track number using the number buttons on the remote control.

Example: To play track 3
Press **3** and press **OK ▶**.

Example: To play track 20
Press **2, 0** and press **OK ▶**.

Playback starts from the beginning of the selected track.

Muting the sound

Press **MUTE**.

The sound is muted, but the play continues.
To unmute the sound, press **MUTE** again.

On Screen Display (OSD) menu

The general playback status can be displayed on the screen. TV
Some items can be changed on the menu.

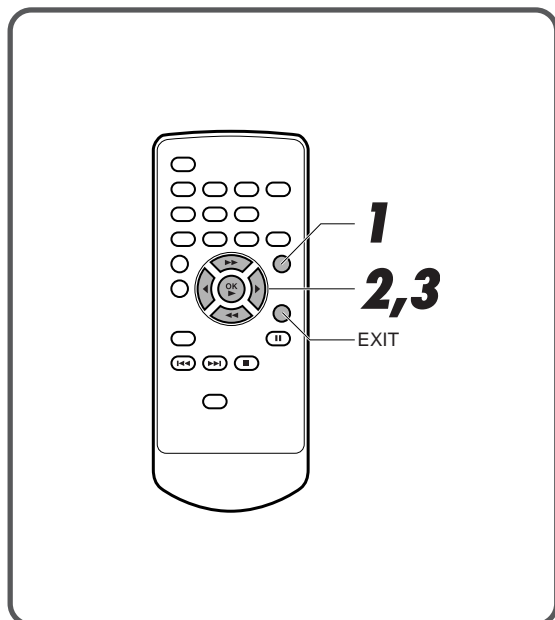

1 Press **ON SCREEN** during playback.

2 Press **◀/▶** to select the desired item.

For DVD, press **▶▶** to go to the second part of the On Screen Display menu, and **◀◀** to return to the first part. Alternatively, press **▶** at the end of the first part to go to the second part, and press **◀** at the beginning of the second part to return to the first part.

The currently selected item is highlighted.

3 Press **◀◀/▶▶** to select the desired setting.

The number buttons can also be used for setting numbers (e.g., title number). For some functions, press **OK ▶** to execute the setting.

To turn off the OSD menu

Press **ON SCREEN** or **EXIT**.

NOTE

If no button is pressed for 10 seconds, the OSD menu disappears.

Examples of On Screen Display (OSD) menu

(The OSD menu may differ depending on the disc contents.)

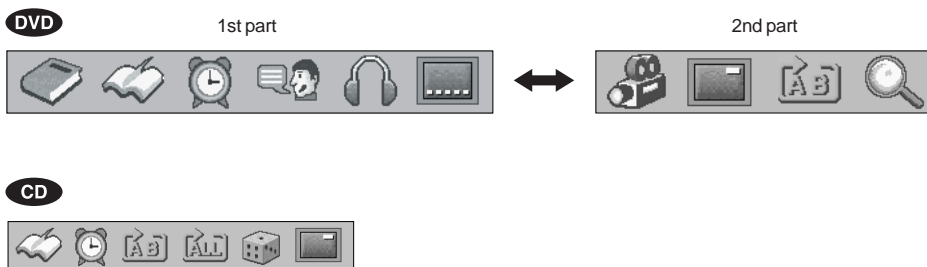









PLAYBACK (CONTINUED)







Detailed description of each OSD menu

Each item shows its current status and can be changed on the OSD menu. For details of the functions or optional settings, refer to the page in parentheses.

DVD

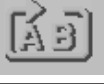
Items	Show the current selected item	Function
	Title number	Skip to the desired title (Title search on page 26)
	Chapter number	Skip to the desired chapter (Chapter/track search on page 27)
	Elapsed playing time	Search the point by the elapsed time directly (Time search on page 27)
	Audio soundtrack language and channel number	Change the setting (page 34)
	Subtitle language	Change the setting (page 35)
	Angle number	Change the angle (page 29)
	On Screen message	Turn on/off the On Screen message (page 33)
	A-B repeat	Repeat a specified portion (page 31)
	Zoom-in/out	Zoom in and out (page 29)

CD

Items	Show the current selected item	Function
	Track number	Skip to the desired track (Chapter/track search on page 27)
	Elapsed playing time	Search the point by the elapsed time directly (Time search on page 27)
	A-B repeat	Repeat a specified portion (page 31)
	1 track repeat/all tracks repeat	Repeat a track or whole disc (page 30)
	Random play	Turn on/of f the random play mode (pae 30)
	On Screen message	Turn on/of f the On Screen message (page 33)

NOTE

Some discs may not provide all of the above OSD menu.

SEARCH

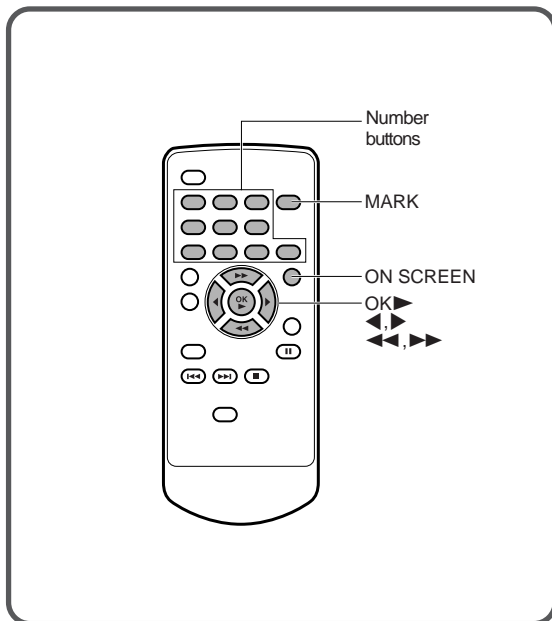

This unit provides 4 types of DVD searches.

DVD

Title search

Specifies a title number .

Chapter/track search

Specifies a chapter or track number .

Time search

Specifies the elapsed time of the desired position.

DVD

Mark search

Specifies the marked point.

Title search

DVD

1 Press **ON SCREEN** during playback.

2 Press **◀/▶** to select the Title icon.



3 Press **◀◀/▶▶** to enter the desired title number.

- The number buttons can also be used to select the desired number .

Example: To play title number 2
Press **2**.

Example: To play title number 10
Press **1, 0**.

4 Press **OK ▶**.

Playback of the specified title starts.

NOTE

If no button is pressed for 10 seconds, the OSD menu disappears.

Chapter/track search

- 1** Press **ON SCREEN** during playback.
- 2** Press **◀/▶** to select the **Chapter/Track** icon.

- 3** Press **◀◀/▶▶** to enter the desired chapter or track number.

- The number buttons can also be used to select the desired number .

Example: To play chapter/track number 2
Press **2**.

Example: To play chapter/track number 17
Press **1, 7**.

- 4** Press **OK ▶**.

Playback of the specified chapter/track starts.

NOTES

- Chapter search does not work on DVDs with no chapters recorded.
- Chapter search will not work if you specify a chapter number which does not exist on the disc.

Time search

When the elapsed time is displayed during playback, you can specify a time on the disc to locate the desired position.

- 1** Press **ON SCREEN** during playback.
- 2** Press **◀/▶** to select the **Time** icon.

- 3** Use the number buttons to enter the time of the desired position.

Example: To start play at 1 hour , 17 minutes, 30 seconds (1:17:30)
Press **1, 1, 7, 3**, then **0**.

Example: To start play at 8 minutes 7 seconds (0:08:07)
Press **0, 8, 0**, then **7**.

- 4** Press **OK ▶**.

Playback starts from the specified position (time).

NOTES

- Time search does not work if you specify a time longer than the length of the disc.
- Time search may not work with some discs even if the elapsed time is displayed.

CONTINUE

SEARCH (CONTINUED)

Mark search

DVD

Playback can restart from the marked point.
Up to 10 points can be marked within the same disc.

To mark a desired point

1 Press MARK at the desired point during playback.

The picture enters the pause mode and the following screen appears.

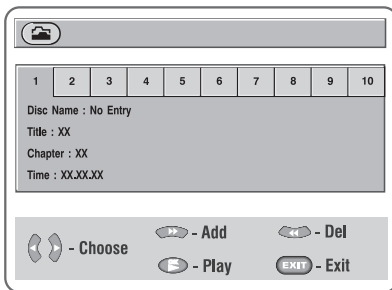

2 Press ◀/▶ to select the desired mark number.

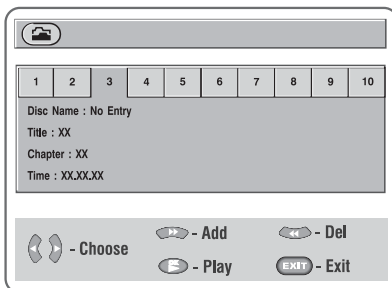

3 Press ▶▶ and then OK ▶.

The point is memorized.

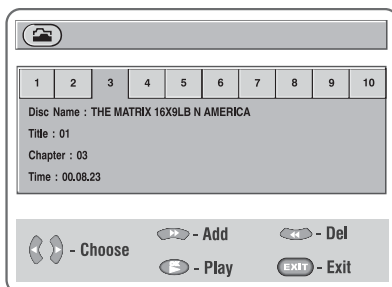

To start play from the marked point

1 Press MARK during playback.

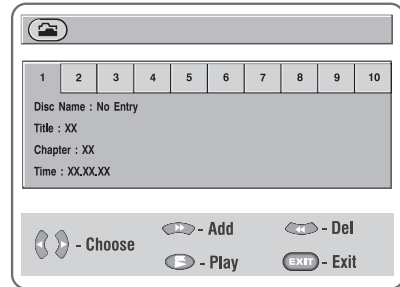

2 Press ◀/▶ to select the desired mark number.

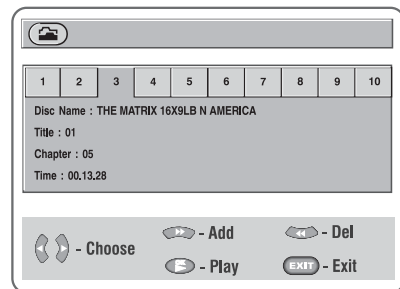

3 Press OK ▶.

Playback resumes from the selected marked point.

NOTES

- Mark search may not work with multi-angle scenes or portions where subtitles are recorded.
- All the marked points are cleared when the power is turned off or the disc tray is opened and closed.

ZOOMING AND CHANGING THE ANGLE

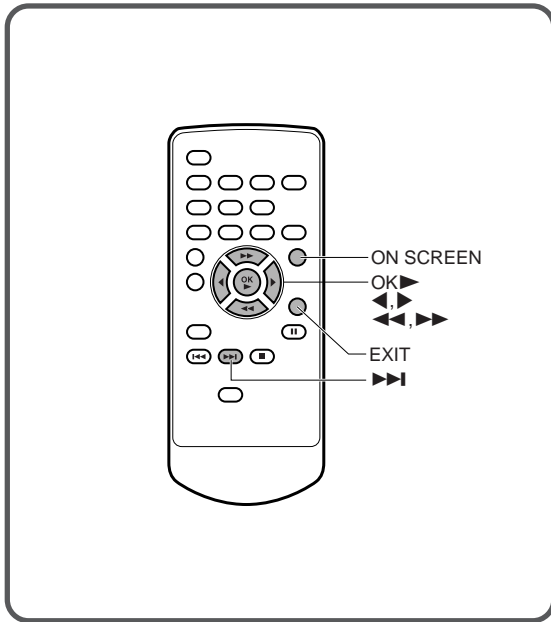

4 Press OK ► repeatedly.

Each time the button is pressed, the magnification changes as shown below .

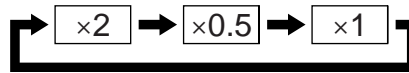

When the selection is completed, press **ON SCREEN** or **EXIT** to turn off the On Screen Display menu.

NOTES

- The zoom function may not work for some DVDs.
- The zoom function may not work on multi-angle scenes.

Changing the angle

DVD

When playing a DVD with multi-angle scenes (photographed from several different angles), you can select the angle you want to view .

1 Press ON SCREEN during playback.

2 Press ►► to go to the second part of the On Screen Display menu.

The Angle icon is selected.



3 Press ◀◀/▶▶ to select the desired angle number.

4 Press OK ►.

Tip

The total number of angles recorded on the DVD appears on the DVD case within the following symbol.



Zooming the picture

DVD

This function allows you to zoom-in (x2) and zoom-out (x0.5) the picture.

1 Press ON SCREEN during playback.

2 Press ►► to go to the second part of the On Screen Display menu.

3 Press ► to select the Zoom icon.



RANDOM AND REPEAT PLAYBACK

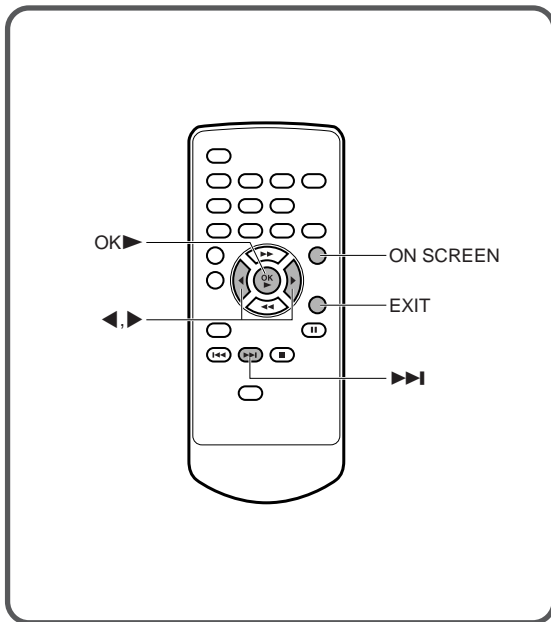

Repeat playback

- 1** Press **ON SCREEN** during playback.
- 2** Press **◀/▶** to select the Repeat icon.

- 3** Press **OK ▶** repeatedly to select the repeat mode.

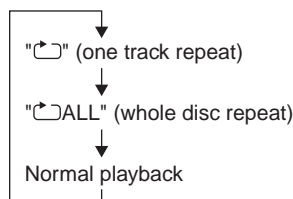
Each time the button is pressed, the repeat mode changes as follows.



When the selection is completed, press **ON SCREEN** or **EXIT** to turn off the On Screen Display menu.

Random playback

- 1** Press **ON SCREEN** during playback or in stop mode.
- 2** Press **◀/▶** to select the Random icon.

- 3** Press **OK ▶** to turn on the random function.

The "RAND" indicator lights in the display window .

If you pressed **ON SCREEN** in stop mode at step 1, press **ON SCREEN** or **EXIT** to turn off the On Screen Display menu, and press **OK ▶** to start random play .

To resume normal playback

Repeat the above procedure to turn off the random function.

Repeating a portion between two specified points (A-B Repeat)

You can select a portion of a track to be repeated. The portion to be repeated cannot span a track boundary, but must be within a single track.

- 1** Press **ON SCREEN** during playback.
- 2** For DVD: Press **▶▶I** to go to the second part of the On Screen Display menu, and press **▶** to select the A-B Repeat icon.
For CD: Press **◀/▶** to select the A-B Repeat icon.

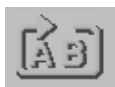

- 3** Press **OK ▶** at the starting point (A) of the section you want to repeat.
- 4** Repeat steps 1 and 2 to select the A-B repeat icon.
- 5** Press **OK ▶** again at the ending point (B) of the section you want to repeat.

The unit returns to point A and plays the section between A and B repeatedly.

To return to the normal playback

Select the A-B repeat icon and press **OK ▶**.

NOTE

At the portion of the disc recorded in multi-angle, the unit may play a section other than you selected for A-B repeat playback.

PROGRAMMED PLAYBACK

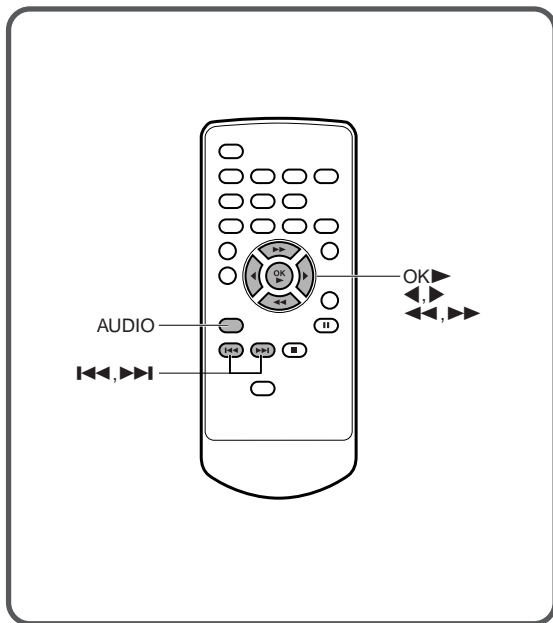

CD

You can select up to 30 tracks, and play them in programmed order .

1 Press AUDIO in stop mode.

The program menu screen appears on the TV screen.

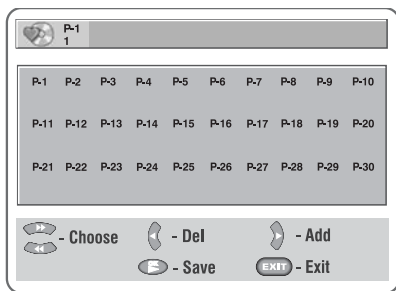

2 Press <</>> to select the desired track number.



3 Press >>.

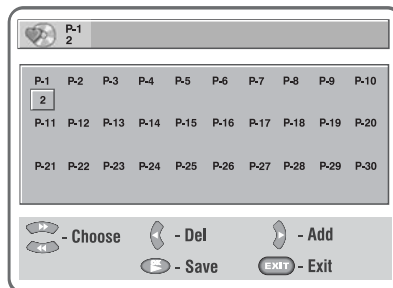

4 Press <</>> to select the next track number.

5 Repeat steps 3 and 4 to select another track.

6 Press OK >>.

The selected tracks are memorized.

7 Press OK >> to start playback.

To skip tracks

Press <<< or >>> repeatedly . Playback skips to the previous or succeeding tracks within the program setting.

To clear all the program settings

Press **AUDIO** in stop mode to call up the program menu screen, and press <<< repeatedly until the first track in the program is deleted. Then press **OK >>**.

DISABLING OSD

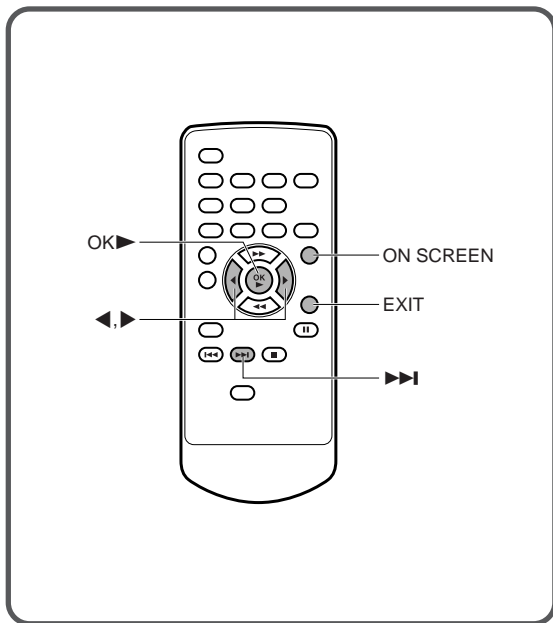

You can inhibit the command responses in the top corner of the TV screen which appears momentarily when you press a button.

- 1** Press ON SCREEN.
- 2** For DVD: Press **▶▶I** to go to the second part of the On Screen Display menu, and press **▶** to select the ON SCREEN icon.
For CD: Press **◀/▶** to select the ON SCREEN icon.

- 3** Press OK **▶** so that "OFF" is displayed.
- 4** Press ON SCREEN or EXIT to turn off the On Screen Display menu.

To turn on the OSD

Repeat the above and select "ON" at step 3.

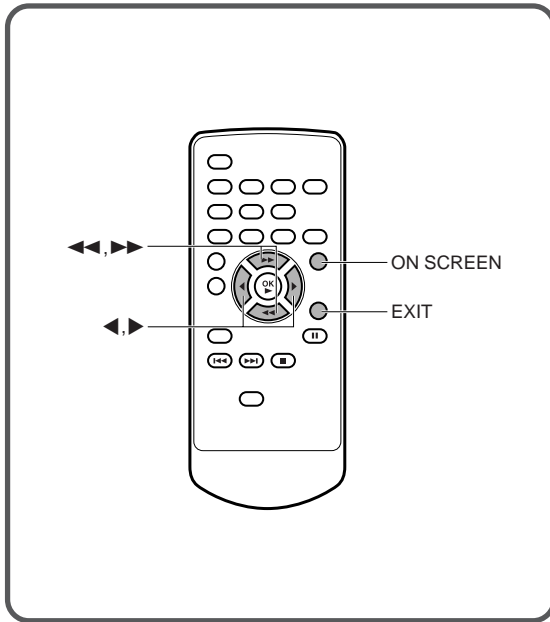
CHANGING THE AUDIO TRACK



DVD

Some discs have more than one audio track, such as soundtracks with different languages. While playing such a disc, the audio track can be changed to play the different soundtracks.

- 1** Press **ON SCREEN** during playback.
- 2** Press **◀/▶** to select the **Language/Sound** icon.

- 3** Press **◀◀/▶▶** to select the desired language and sound channel.
- 4** Press **ON SCREEN** or **EXIT** to turn off the On Screen Display menu.

- When playing a DVD with soundtracks in multiple languages, the audio will automatically be played in the designated language set in the setup menu (page 41). If that language is not on the disc, the original language for the disc is selected.
- The audio track may only be changed for discs which contain multiple audio tracks.
- The number of audio tracks available differs from disc to disc.

Tip

The total number of soundtracks on the DVD appears on the DVD case within the following symbol.



DISPLAYING AND CHANGING SUBTITLES

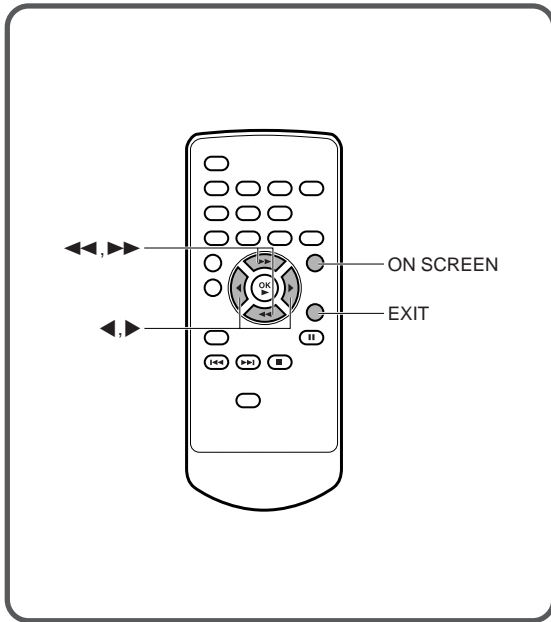

- The subtitle is displayed in the designated language set in the set up menu (page 41). If that language is not on the disc, the original language for the disc is selected.
- Subtitles may only be changed with discs which contain more than one set of subtitles.
- The number of subtitle languages differs depending on the disc.

Tip

The total number of subtitle languages on the DVD appears on the DVD case within the following symbol.



DVD

When playing DVD discs which contain subtitles, you can display the subtitles on the screen or change the language of the subtitles.

- 1** Press **ON SCREEN** during playback.
- 2** Press **◀/▶** to select the Subtitle icon.

- 3** Press **◀◀/▶▶** to select the desired language.
- 4** Press **ON SCREEN** or **EXIT** to turn off the On Screen Display menu.

To cancel the Subtitles

Select "Of f" at step 3 above.

NOTE

When playing a disc supporting closed captions, the subtitle and the closed captions may overlap each other on the screen. In this case, turn the subtitle setting of TV f.

PLAYING BACK AN MP3 DISC

The unit can play back MP3s recorded on CD-ROM, CD-R or CD-RW discs.

Before playing back an MP3 disc, read the following notes.

Notes on MP3 discs

An MP3 file stores audio data compressed using MPEG1, the audio layer-3 file-coding scheme.

In this manual, we refer to what, in PC terminology, are called "folders" and "files" as "albums" and "tracks".

Notes on playing MP3s

- An MP3 track must be recorded on a disc in the format compliant with ISO 9660. Note however, that the unit may not play tracks in the order they were recorded.
- The maximum allowable number of tracks and/or albums in a disc is 900, including the root albums (directory).
- The maximum allowable depth of a nested folder is 127, including files.
- If a disc contains audio tracks and MP3 tracks, the unit cannot play it.
- As for multi-session discs, the unit can play up to 20 sessions.
- The unit can play only MP3 tracks which were converted with a sampling frequency of 44.1 kHz and a fixed bit rate of 128 kbps.
- The unit may not play MP3 tracks recorded using a packet writing utility.
- The unit can play only MP3 tracks having a file extension ".mp3".
- It may take 30 seconds or more before the unit can start play of MP3 tracks, depending on the number of recorded tracks and the complexity of the album tree.
- If you play a non-MP3 track that has the ".mp3" file extension, it will skip to the next valid track automatically.
- Digital recordings with this unit cannot be done while playing back MP3 discs.

Notes on display indications during playback

- Up to 8 characters are displayed for the name of an album or track.
- Characters other than uppercase letters ("A" to "Z"), numerals ("0" to "9") and underscore ("_") may not be displayed, or may be displayed in different characters.
- The elapsed playing time may not be displayed correctly for MP3 tracks.
- Depending on the condition of the recording equipment or the CD-R/RW disc itself, a false album or track which cannot be played on the unit may be displayed on TV screen.

Notes on creating MP3 discs

- When converting audio data to MP3
Create MP3 files with a sampling frequency of 44.1 kHz and a fixed bit rate of 128 kbps.
- When creating MP3 discs
Do not store more than 900 albums and/or tracks in a disc.
- To play tracks in the order they were recorded
 1. Use a writing software capable of recording MP3 tracks (files) in numerical and alphabetical order. For details on using the software, refer to the operating instructions supplied with the software.
 2. Use only one album. (Do not create a sub-album within an album.)
 3. Include a two or three-digit number at the beginning of each album or track name so that the albums and tracks are played in order.
<Example of recommended name structure>
01XXXXX.mp3
02XXXXX.mp3
03XXXXX.mp3
04XXXXX.mp3
05XXXXX.mp3
<Avoid using the following structure>
1XXXXX.mp3
5XXXXX.mp3
10XXXXX.mp3
15XXXXX.mp3
20XXXXX.mp3
(The beginning numbers determine the order, therefore the tracks shown above will be played in wrong order, i.e., "1", "10", "15", "20", and "5".)

Glossary

File extension:

A 3-character string added to a file name under the Windows or DOS environment is called a "file extension". A file extension is used mainly to identify types of files. The file extension for MP3 files is ".mp3".

ISO 9660:

ISO stands for the "International Organization for Standardization". ISO 9660 determines the file structure for the CD-ROMs. This unit can play MP3 files recorded in the format compliant with ISO 9660.

Nesting of folders (albums):

To organize data files stored in a PC, you can store related files in a folder. A folder can contain other folders as well as files. For example, folder A can contain folder B, and folder B can contain folder C; this is called "nesting of folders".

Session:

A session is one uninterrupted section of written data on a disc.

A multi-session disc is a disc which has more than two sessions.

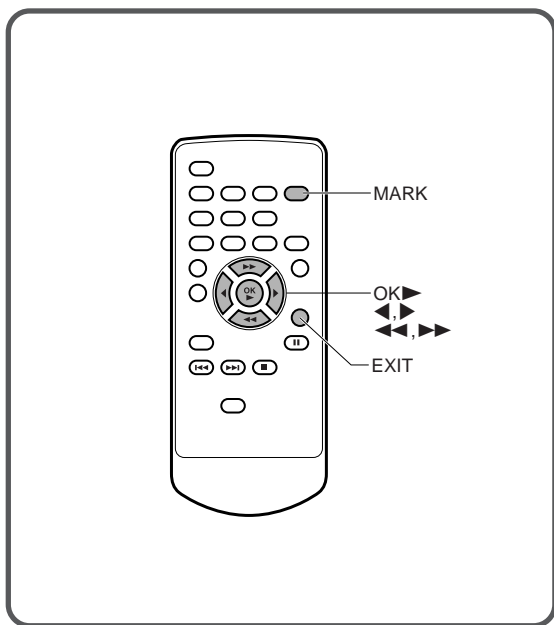

- ① Track number being played/total number of tracks in the MP3 Songs Selection List*.
- ② Track name
- ③ Audio mode (stereo or monaural)
- ④ Bit rate
- ⑤ Responds to MARK and allows you to edit the MP3 Songs Selection List.
- ⑥ Responds to ►► and skips to the next track.
- ⑦ Responds to ■ and stops playback.
- ⑧ Responds to OK ► and starts playback.
- ⑨ Responds to || and pauses playback.
- ⑩ Responds to ◀◀ and skips to the previous track.
- ⑪ Sampling frequency
- ⑫ Elapsed time of the currently played track.

* The MP3 Songs Selection List can be opened by pressing **MARK** on the remote control, and when an MP3 disc is loaded, all tracks on the disc are placed in this list.

NOTE

It may take over 30 seconds to read the MP3 tracks depending on the complexity of the album tree.

Playing back an MP3 disc

Load an MP3 disc.

The MP3 Player panel is displayed on the TV screen and the first track begins to play .

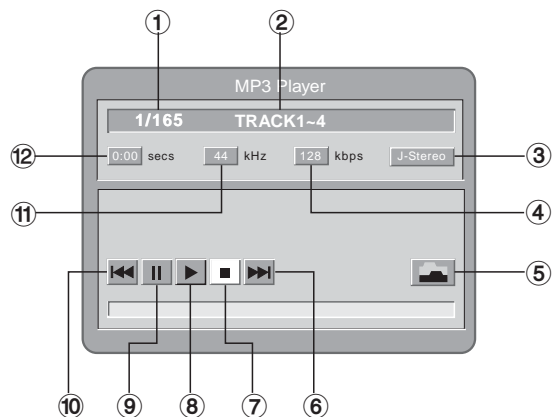

Editing the MP3 Song Selection List

When the MP3 Player panel is displayed, press MARK.

The MP3 Song Selection List is displayed.

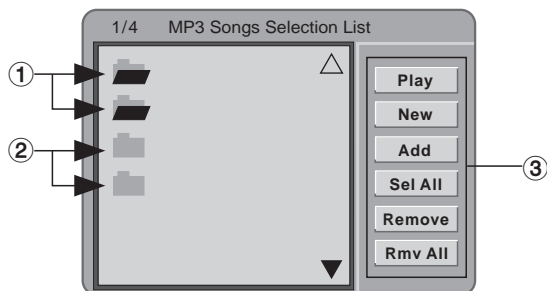

- ① Tracks selected
- ② Tracks not selected
- ③ Command box

To select/deselect tracks

Press ◀◀/▶▶ to highlight a track and press **OK ►**. Each time the button is pressed, the track is selected and deselected.

PLAYING BACK AN MP3 DISC (CONTINUED)

Using the command box

Using the commands in the command box, you can create your own MP3 Songs Selection List.

To use the commands

On the MP3 Songs Selection List, press **▶** and the command box is highlighted.

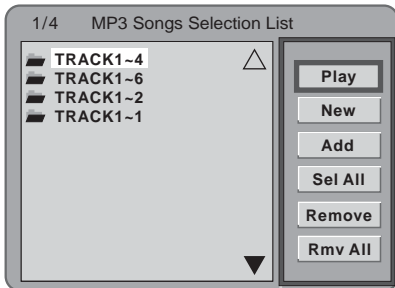

Then press **◀◀/▶▶** to select a command and press **OK ▶**.

The selected command will be executed.

[Play] command

Starts playback of the tracks selected on the MP3 Songs Selection List.

The display returns to the MP3 Player panel.

[New] command

Clears all tracks from the MP3 Songs Selection List and allows you to select the tracks to be played from the beginning.

When the [New] command is executed, the MP3 Disc Browser appears on the TV screen.

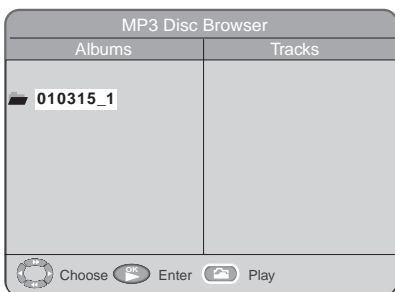

Proceed as follows to select tracks.

- 1 Press **◀◀/▶▶** to select the disc and press **OK ▶**. Albums in the disc are displayed.

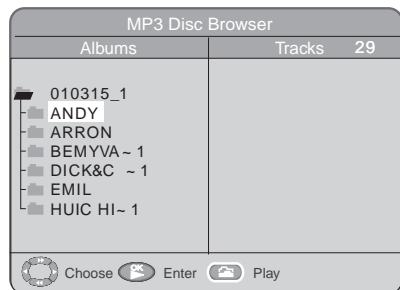

- 2 Press **◀◀/▶▶** to select an album and press **OK ▶**. Tracks in the album are displayed and can be selected.

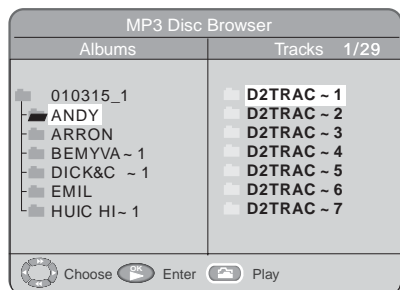

- 3 Press **◀◀/▶▶** to select a track and press **OK ▶**. Repeat this to select other tracks.

- 4 Press **MARK** or **EXIT**. The display returns to the MP3 Player panel, and the selected tracks start to play.

[Add] command

Allows you to add tracks to the MP3 Songs Selection List. When you execute this command, the MP3 Disc Browser appears.

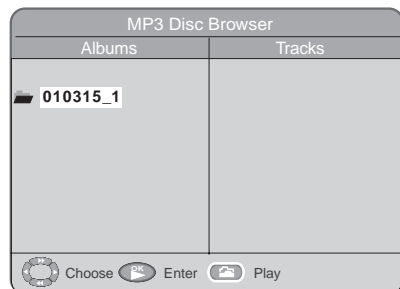

Proceed in the same manner as the [New] command to select the tracks to add to the MP3 Songs Selection List.

[Sel All] command

When you execute this command, all the tracks on the MP3 Songs Selection List are selected for play .

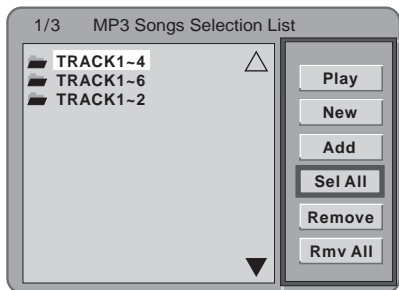

[Rmv All] command

This command removes all the tracks from the MP3 Songs Selection List.

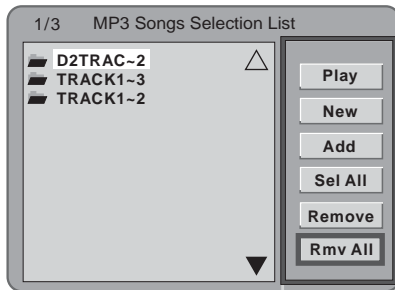

[Remove] command

This command removes the currently selected track from the MP3 Songs Selection List.

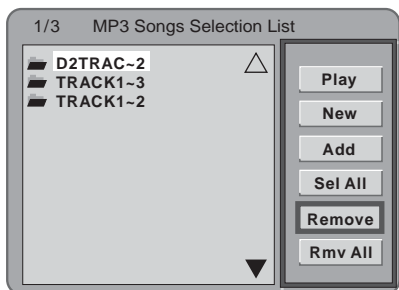
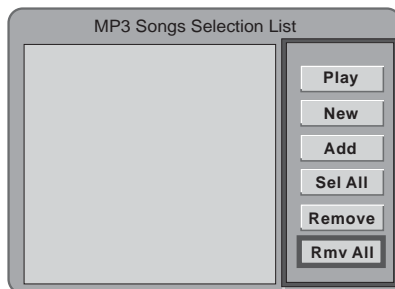
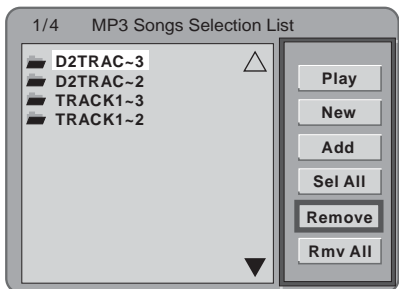

CHANGING SETUP VALUES

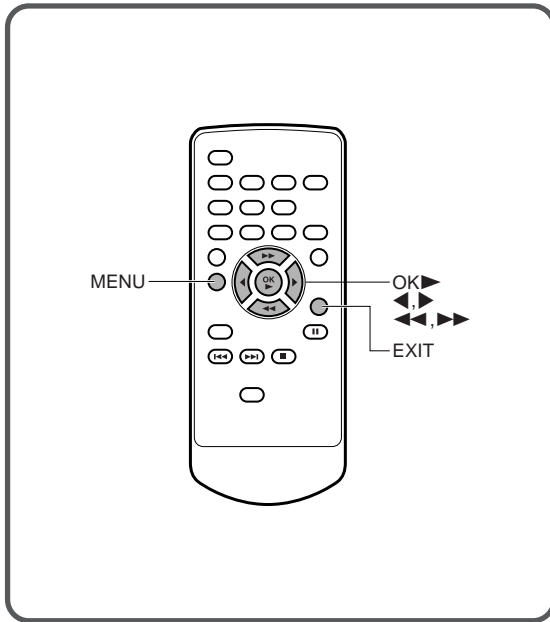

All the basic settings of the unit are properly preset at the factory.

- Check that "Digital out" and "TV aspect" in the setup menu are correctly set according to the type of equipment connected to the unit. For details on the setting, refer to the "Connections" section on pages 11 to 19.
- Change any other settings according to your individual setup preferences.

Basic operations

1 Press MENU in stop mode.

The setup menu is displayed.

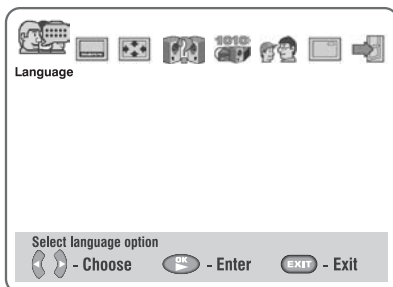

2 Press ◀/▶ to select the item to be changed, then press OK ▶.

Language

Sets the audio soundtrack language, subtitle language, DVD menu screen language and on screen display language.

Subtitle

Turns on and off the subtitle.

TV aspect

Sets the color system and aspect ratio of the TV connected to the unit.

Audio set

Emits test tone and adjusts the DRC (Dynamic Range Control).

Digital out

Sets the digital audio to be output from the unit according to the type of audio equipment connected to the unit.

Parental

Sets the preset restriction level for playback.

When playing discs with preset restriction level encoding, the unit automatically cuts scenes of excessive violence, etc.

On screen

Turns on and off the command response shown on the top corner of the TV screen.

Quit

Exits the setup menu.

3 Press ◀◀/▶▶ to select the desired setting and press OK ▶.

4 Press ◀◀/▶▶ to select "Return" and press OK ▶.

Some items require additional steps.

For details of the setting options for each item, see the procedure of each setting on the following pages.

To exit the setup menu

Select "Quit" and press **OK ▶**, or press **EXIT**.

Language

- 1 Press ◀/▶ to select "Language" on the setup menu and press OK ▶.

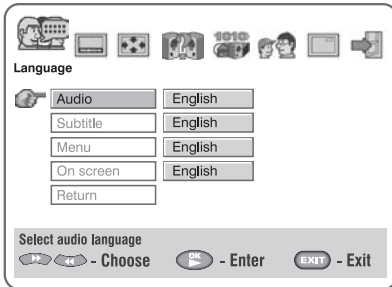

- 2 Press ◀◀/▶▶ to select the desired item.

Audio:

The audio soundtrack language on a DVD disc can be changed. If the selected language is not available on the disc, the original language for the disc is selected.

Subtitle:

The subtitle language on a DVD disc can be changed. If the selected language is not available on the disc, the original language for the disc is selected.

Menu:

The language used in the DVD menu can be changed. If the selected language is not available on the disc, the original language for the disc is selected.

On screen:

The language used in the setup menu as well as the command response, etc., can be changed.

- 3 Press OK ▶.

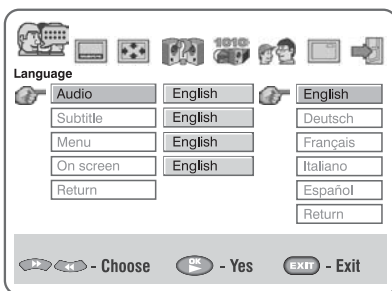

- 4 Press ◀◀/▶▶ to select the desired language.

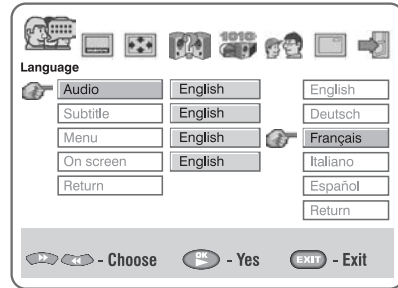

- 5 Press OK ▶.

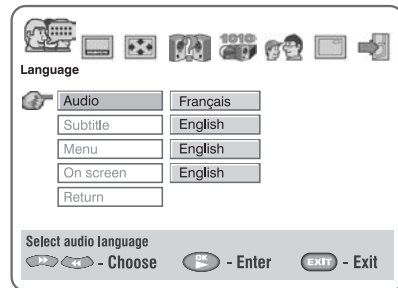

- 6 Press ◀◀/▶▶ to select "Return" and press OK ▶.

To exit the setup menu

Select "Quit" and press OK ▶, or press EXIT.

CHANGING SETUP VALUES (CONTINUED)

Subtitle

The subtitle can be turned on or off.

- 1 Press **◀/▶** to select "Subtitle" on the setup menu and press **OK ▶**.

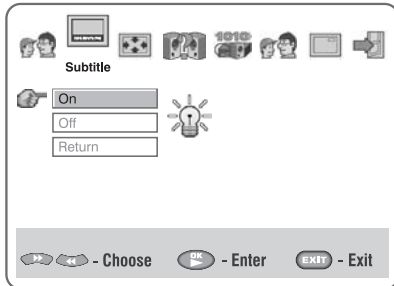

- 2 Press **◀◀/▶▶** to select "On" or "Off".

On:
Turns on the subtitle.

Off:
Turns off the subtitle.

- 3 Press **OK ▶**.

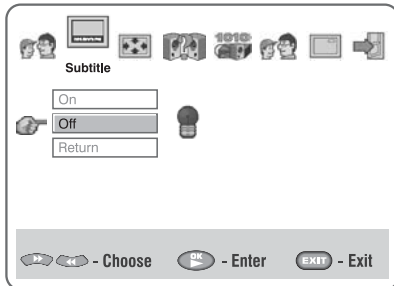

- 4 Press **◀◀/▶▶** to select "Return" and press **OK ▶**.

To exit the setup menu

Select "Quit" and press **OK ▶**, or press **EXIT**.

TV aspect

To set the TV color format

Normally, it is not necessary to change this setting. The TV color format can be selected according to the disc to be played.

- 1 Press **◀/▶** to select "TV aspect" on the setup menu and press **OK ▶**.

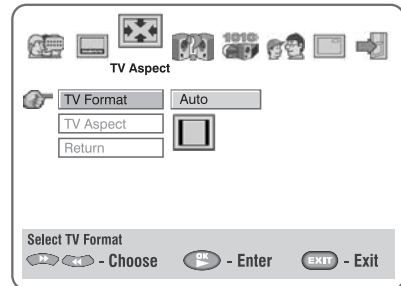

- 2 Confirm that "TV Format" is selected, and press **OK ▶**.

- 3 Press **◀◀/▶▶** to select the desired item.

Auto: (default setting)

The unit detects automatically the TV color format of the disc, NTSC or PAL.

PAL M/N:

Select this when the connected TV corresponds to PAL-M or PAL-N.

PAL B/G/I:

Select this when the connected TV corresponds to PAL-BG/DK or PAL-I.

- 4 Press **OK ▶**.

If you select "Return" at step 3, the current setting does not change.

- 5 Press **◀◀/▶▶** to select "Return" and press **OK ▶**.

To exit the setup menu

Select "Quit" and press **OK ▶**, or press **EXIT**.

To set the TV aspect

Select the appropriate screen type of your TV.

- 1** Press **◀/▶** to select "TV aspect" on the setup menu and press **OK ▶**.
- 2** Press **◀◀/▶▶** to select "TV Aspect" and press **OK ▶**.

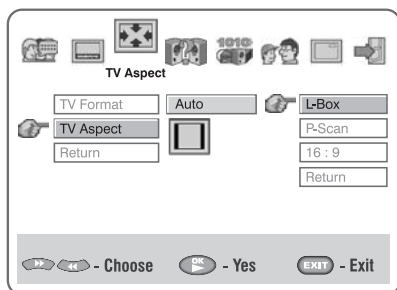

- 3** Press **◀◀/▶▶** to select the desired item.

L-Box:

Select this when a conventional TV is connected. Media recorded in wide (16:9) format will be played in "Letterbox" style, with black bands at the top and bottom of the screen.



P-Scan:

Select this when playing media that contains pan-scan encoding. Media recorded in wide (16:9) format will be played at the full screen height, with the left and right portions cut off.

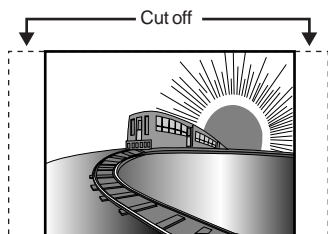

16:9:

Select this when a wide-screen TV is connected. Played in "FULL" size. (Setting the wide-screen TV to "FULL" mode is also necessary.)

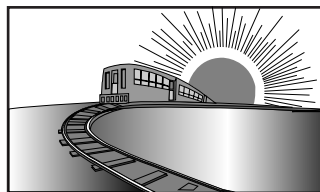

- 4** Press **OK ▶**.

If you select "Return" at step 3, the current setting does not change.

- 5** Press **◀◀/▶▶** to select "Return" and press **OK ▶**.

To exit the setup menu

Select "Quit" and press **OK ▶**, or press **EXIT**.

CHANGING SETUP VALUES (CONTINUED)

Audio set

To emit test tone

You can hear a noise tone emitted from the front left and right speakers alternately .

If the noise tone from the left speaker and the right speaker are heard unevenly , adjust the left and right speaker balance using the connected equipment.

- 1 Press ◀/▶ to select "Audio set" on the setup menu and press OK ▶.

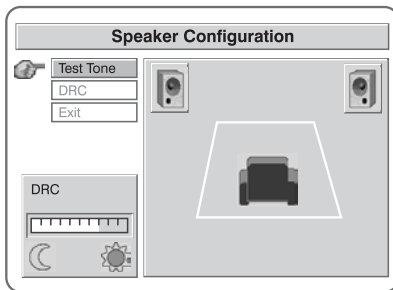

- 2 Confirm that "Test Tone" is selected, and press OK ▶.

Noise tone is emitted from the front left and right speakers alternately .

- 3 Press OK ▶ to stop the noise tone.

- 4 Press ◀◀/▶▶ to select "Exit" and press OK ▶.

To exit the setup menu

Select "Quit" and press OK ▶, or press EXIT.

To adjust DRC (Dynamic Range Control)

When listening at a low volume, the volume of loud sounds such as explosions, etc., can be reduced, and the volume of quiet sounds such as whispered dialog, etc., can be increased using the DRC.

- 1 Press ◀/▶ to select "Audio set" on the setup menu and press OK ▶.

- 2 Press ◀◀/▶▶ to select "DRC" and press OK ▶.

- 3 Press ◀/▶ to adjust DRC.

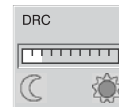

Select this mode when playing back at a low volume. Pressing ◀ twice at the above illustration makes DRC maximum.

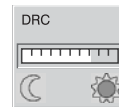

Select this mode when you want to enjoy the full dynamic range of sound.

Pressing ▶ three times at the above illustration makes DRC minimum.

- 4 Press OK ▶.

- 5 Press ◀◀/▶▶ to select "Exit" and press OK ▶.

To exit the setup menu

Select "Quit" and press OK ▶, or press EXIT.

Digital out

Each DVD disc has a variety of audio output options. Set the digital output of the unit according to the type of audio system you use.

CAUTION

When connecting an AV receiver not equipped with a Dolby Digital decoder or DTS decoder, do not set "Dolby Digital" to "Bitstream" and "DTS" to "Bitstream".

Merely attempting to play a DVD may cause a screeching of noise which could be harmful to your ears and damage the speakers. In such a case, set "Dolby Digital" to "PCM" and "DTS" to "Off".

1 Press ◀/▶ to select "Digital out" on the setup menu and press OK ▶.

2 Press ◀◀/▶▶ to select the desired item and press OK ▶.

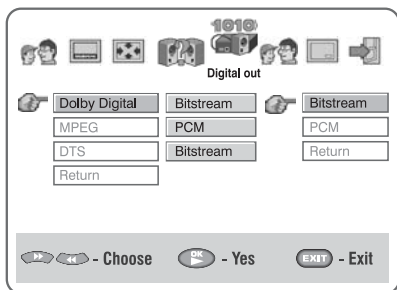

3 Press ◀◀/▶▶ to select the desired item.

Dolby Digital:

You can select "Bitstream" or "PCM".

- Bitstream : select this when the connected AV receiver is equipped with a Dolby Digital decoder .
- PCM : select this when the connected AV receiver is not equipped with a Dolby Digital decoder .

MPEG:

You can select "Bitstream" or "PCM".

- Bitstream : select this when the connected AV receiver is equipped with a MPEG decoder .
- PCM : select this when the connected AV receiver is not equipped with a MPEG decoder .

DTS:

You can select "Bitstream" or "Off".

- Bitstream : select this when the connected AV receiver is equipped with a DTS decoder .
- Off : select this when the connected AV receiver is not equipped with a DTS decoder .

4 Press OK ▶.

5 Press ◀◀/▶▶ to select "Return" and press OK ▶.

To exit the setup menu

Select "Quit" and press OK ▶, or press EXIT.

CONTINUE

CHANGING SETUP VALUES (CONTINUED)

Parental

Some DVD discs contain a restriction level which enables parents to remove scenes or prevent children from playing the discs. This unit is equipped with a password designed to prevent children from changing the level.

To set the parental lock level and password

- 1 Press **◀/▶** to select "Parental" on the setup menu and press **OK ▶**.

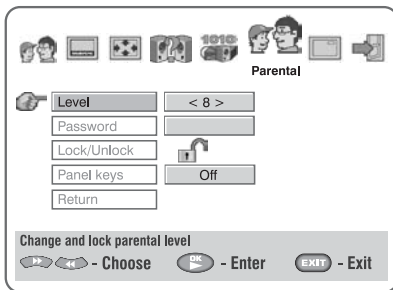

- 2 Confirm that "Level" is selected, and press **OK ▶**.

- 3 Press **◀/▶** to change the parental lock level.

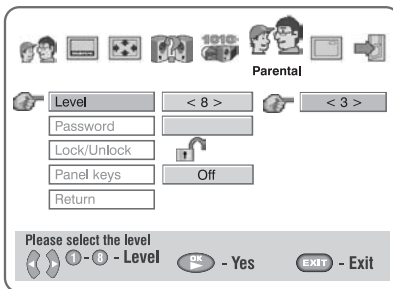

The parental lock level is equivalent to the following USA movie ratings.

Example:
Level 7: NC-17 Level 6: R Level 4: PG 13
Level 3: PG Level 1: G

- 4 Press **OK ▶**.

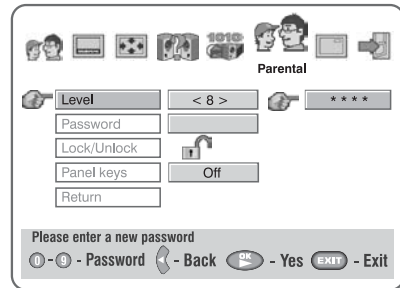

- 5 Enter a 4-digit password using the number buttons, then press **OK ▶**.

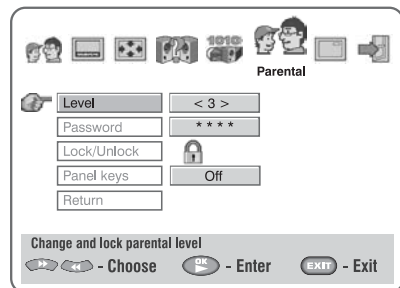

Example: To set the password 1234
Press **1, 2, 3** and **4**.

Do not forget your password.

6 Press ◀◀/▶▶ to select "Return" and press OK ▶.

To change the password

- 1 Select "Parental" on the setup menu and press OK ▶.
- 2 Press ◀◀ to select "Password" and press OK ▶.
- 3 Enter the current password and press OK ▶.
- 4 Enter the new password and press OK ▶.

To unlock the current level

- 1 Select "Parental" on the setup menu and press OK ▶.
- 2 Press ◀◀ twice to select "Lock/Unlock" and press OK ▶.
- 3 Enter the password and press OK ▶.

To lock the current level again, repeat the above.

To disable the front panel buttons

When you disable the front panel buttons, the buttons on the unit become inoperative except **POWER**. The unit can be operated by the remote control only .

- 1 Select "Parental" on the setup menu and press OK ▶.
- 2 Press ◀◀ three times to select "Panel keys" and press OK ▶.
- 3 Press ◀◀ to select "Off" and press OK ▶.

To exit the setup menu

Select "Quit" and press OK ▶, or press EXIT.

On screen

You can turn on and off the command response shown on the top corner of the TV screen.

1 Press ◀/▶ to select "On screen" on the setup menu and press OK ▶.

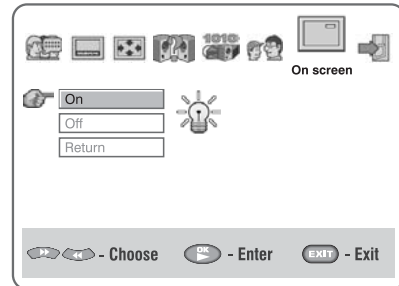

2 Press ◀◀/▶▶ to select "On" or "Off".

On:

Turns on the command responses.

Off:

Turns off the command responses.

3 Press OK ▶.

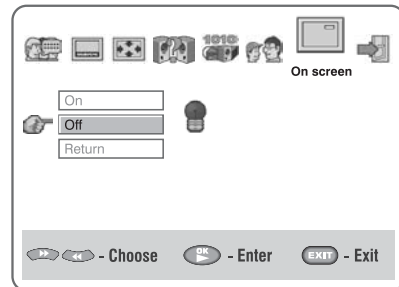

4 Press ◀◀/▶▶ to select "Return" and press OK ▶.

To exit the setup menu

Select "Quit" and press OK ▶, or press EXIT.

TROUBLESHOOTING

If something seems to be wrong with your DVD player, first check the items in the table below.

Symptom	Check	See page
The power does not come on.	<ul style="list-style-type: none"> Is the power cord plugged firmly into a live outlet? 	11
The disc does not play. Playback stops almost immediately.	<ul style="list-style-type: none"> Is there condensation inside the unit? (Leave the player idle with the power on for 1 to 2 hours.) 	2
	<ul style="list-style-type: none"> Are you trying to use a disc not available for the unit, such as a PHOTO CD? Is the disc dirty? Is it loaded properly? Does the disc exceed the specified parental control rating level? 	4 6, 20 46
No picture.	<ul style="list-style-type: none"> Is the unit connected correctly? Are the video connections firmly attached? Is the television video mode set correctly? 	11 11 20
	<ul style="list-style-type: none"> Is the unit in a place subject to vibrations? Are the video connections firmly attached? Is the disc dirty? 	2 11 6
	<ul style="list-style-type: none"> Is the unit connected directly to the TV? Or is it connected through a VCR, a selector switch, or a TV/VCR? The picture may be bad when used with some television sets or projectors, due to the DVD copy protection scheme. The picture quality may also suffer if the DVD player is connected through a selector switch with other video equipment. Try turning off the power to the other video equipment. The picture quality may be somewhat poor when paused, when doing Frame Advance, or during fast forward or fast reverse. This is normal. Is the TV color format set correctly? 	11 11 20 42
No sound.	<ul style="list-style-type: none"> Is the unit connected correctly? Are the audio connections firmly attached? Is the connected audio equipment turned on? Is the volume set correctly? (Note that there will be no audio playback during slow playback, Frame Advance, fast forward, or fast reverse.) 	11 11 20
	<ul style="list-style-type: none"> Are the remote control batteries installed correctly? Is the remote control too far from the main unit? Is there something in the way? Are the remote control batteries getting weak? Is the unit in strong sunlight or strong fluorescent light? 	7 7 7 7

DVD has many capabilities

Some of these capabilities may differ based on the disc being played. The following situations may be caused by information on the disc itself.

- The audio or subtitles are not reproduced in the language specified in the setup menu.
- The audio track or subtitles cannot be changed.
- Subtitles are not displayed.
- The DVD menu is not displayed. The DVD menu is not displayed in the language you want.
- The viewing angle cannot be changed.
- The rating restriction does not work.

SPECIFICATIONS

Power supply	120 V AC, 60 Hz
Power consumption	20 W
Power consumption in standby mode	8 W
Weight	2.9 kg (6.6 lbs)
External dimensions	430 × 77 × 280 mm (w × h × d) (17 × 3 1/8 × 11 1/8 inches)
Laser	Semiconductor Laser , wavelength 650/780 nm
Signal format	NTSC/PAL
Supported discs	DVD video discs 12 cm (single-sided single-layer, single-sided double-layer, double-sided double-layer) 8 cm (single-sided single-layer, single-sided double-layer, double-sided double-layer) Compact discs (CD-DA) 12 cm and 8 cm discs
S video output	Y output: 1 Vp-p (75 ohms, sync negative) C output: 0.3 Vp-p 1 Mini Din 4 pin
Video output	Video composite output 1 Vp-p (75 ohms, sync negative) 2 RCA jacks Video component output Y output: 1 Vp-p (75 ohms, sync negative) C _B , C _R output: 0.7 Vp-p (75 ohms) 3 RCA jacks (C _B , C _R , Y)
Audio output	Digital output 0.5 Vp-p (75 ohms) 1 RCA jack Analog output 2.0 Vrms (1 kHz, 0 dB, 330 ohms) 2 RCA jacks (L/R)
Audio output characteristics	Signal to noise ratio More than 100 dB (EIAJ) Dynamic range More than 90 dB (EIAJ) Harmonic distortion 0.008% Frequency range: CD: 4 Hz to 20 kHz DVD: 4 Hz to 22 kHz (48 kHz sampling) 4 Hz to 44 kHz (96 kHz sampling)
Operating conditions	5°C to 35°C (41°F to 95°F)
Accessories	Audio/video cord (1) Remote control (1)

Specifications are subject to change without notice.

NOTE

This equipment has been tested and found to comply with the limits for a Class B digital device, pursuant to Part 15 of the FCC Rules. These limits are designed to provide reasonable protection against harmful interference in a residential installation.

This equipment generates, uses, and can radiate radio frequency energy and, if not installed and used in accordance with the instructions, may cause harmful interference to radio communications. However, there is no guarantee that interference will not occur in a particular installation. If this equipment does cause harmful interference to radio or television reception, which can be determined by turning the equipment off and on, the user is encouraged to try to correct the interference by one or more of the following measures:

- Reorient or relocate the receiving antenna.
- Increase the separation between the equipment and receiver.
- Connect the equipment into an outlet on a circuit different from that to which the receiver is connected.
- Consult the dealer or an experienced radio/TV technician for help.

CAUTION

Modifications or adjustments to this product, which are not expressly approved by the manufacturer, may void the user's right or authority to operate this product.

- Manufactured under license from Dolby Laboratories. "Dolby", "Pro Logic" and the double-D symbol are trademarks of Dolby Laboratories. Confidential unpublished works. ©1992-1997 Dolby Laboratories. All rights reserved.
- Manufactured under license from Digital Theater Systems, Inc. US Pat. No. 5,451,942 and other worldwide patents issued and pending. "DTS" and "DTS Digital Surround" are trademarks of Digital Theater Systems, Inc. ©1996 Digital Theater systems, Inc. All rights reserved.

AIWA CO.,LTD.

 <http://www.aiwa.co.jp>

For Assistance and Information, **Call Toll Free 1-800-BUY-AIWA** (United States and Puerto Rico)

Printed in China